

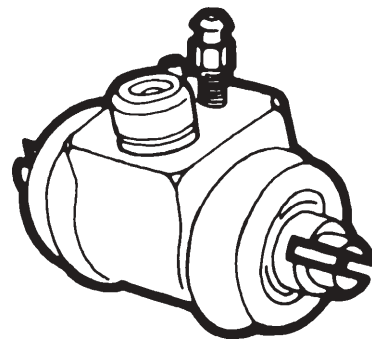

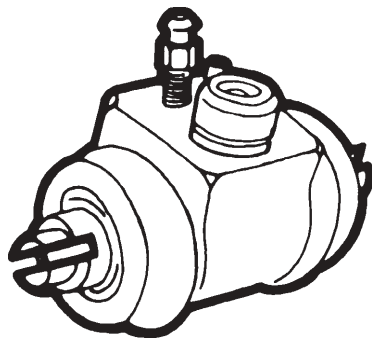

RADBREMSZYLINDER & REPARATURSÄTZE



**BRUGSVEJLEDNING OG INDHOLDSFORTEGNELSE
DIRECTIONS FOR USE AND CONTENTS
BESTELLHINWEISE UND INHALTSVERZEICHNIS**

80.... HJULCYLINDER WHEELCYLINDER RADZYLINDER
87.... REPARATIONSSÆT REPAIR KIT REPARATURSATZ

	GRUPPE NR. GROUP NO. GRUPPE NR.	SIDE PAGE SEITE		GRUPPE NR. GROUP NO. GRUPPE NR.	SIDE PAGE SEITE
ALFA ROMEO	10	5	MITSUBISHI	30	41
AUDI	47	6	NISSAN	22	43
AUTOBIANCHI	23	9	OPEL	36	46
BARKAS	59	9	PEUGEOT	37	51
BEDFORD	14	9	PORSCHE	56	54
BMW	15	10	RENAULT	39	55
CITROEN	19	13	ROVER GROUP	40	60
DACIA	39	17	AUSTIN		
DAEWO	50	17	LEYLAND		
DAIHATSU	51	18	TRIUMPH		
FIAT	23	19	SAAB	41	62
FORD	25	24	SEAT	23	63
FORD USA	25	31	SKODA	43	64
HANOMAG	28	31	SUBARU	44	64
HONDA	26	32	SUZUKI	52	64
HYUNDAI	34	34	TALBOT	18	65
ISUZU	14	35	TOYOTA	45	66
KIA	35	35	TRABANT	58	68
LADA	23	36	VAUXHALL	36	69
LANCIA	23	36	VW VAG	47	72
LAND ROVER	40	37	VOLVO	48	77
MAZDA	32	38	WARTBURG	49	79
MERCEDES-BENZ	33	40	YUGO (ZASTAVA)	23	79
MCC	33	40			
Anvendelsesliste/Buyers guide/Nummerische Liste				Side/Page/Seite	81-92
III. udluftningsskruer/III. Bleeder screws/Abb. Entlüftungsschrauben				Side/Page/Seite	93-94

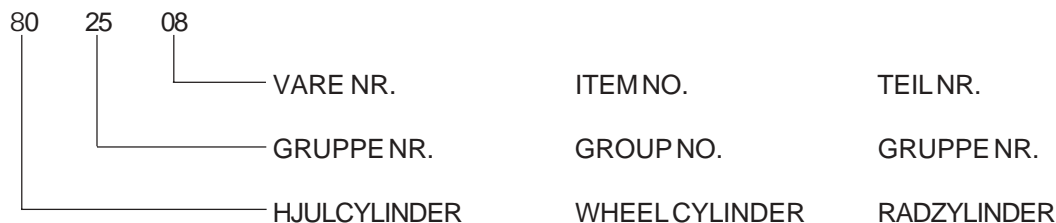

Vi gør opmærksom på, at gruppe nr. kan forekomme indenfor flere bilmærker.
Please notice that group no. can occur in more than one mark.
Bitte beachten Sie, dass diese Artikelnummern bei mehreren Fahrzeuganwendungen verwendet wird.

FORKORTELSER	ABBREVIATIONS	ABKÜRZUNGEN
B: Bag	Rear	hinten
F: For	Front	vorne
U: Udgår	Available only while stock last	entfällt

HENVISNINGER	NOTEKEY	HINWEISE
1 : Uden udligningsventil	Without brake pressure valve	ohne Bremskraftregler
2 : Med udligningsventil	With brake pressure valve	mit Bremskraftregler
3 : Justerhus	Adjuster	Nachstellung
4 : Bendix bremsler for	Bendix front brakes	VA Bendix Bremsen
5 : Citroën bremsler for	Citroën front brakes	VA Citroën Bremsen
6 : Med indbygget reguleringsventil	With adjustment valve	mit integriertem Regler
7 : Uden indbygget reguleringsventil	Without adjustment valve	ohne integriertem Regler
8 : Med mm. gevind	With mm. thread	mit mm. Gewinde
9 : Med tvilling montering	With dual tires	mit Doppelbereifung
10 : Med bremsetromler for	Front drum brakes	Trommelbremsen vorne
11 : Med " gevind	With " thread	mit " Gewinde
12 : Hjulafstand 2950 mm.	Wheelbase 2950 mm.	Radstand 2950 mm.
13 : Hjulafstand 3650 mm.	Wheelbase 3650 mm.	Radstand 3650 mm.
14 : 1 Kreds	Single line	Einkreisanlage
15 : Med selvjustering	With self adjustment	mit Selbstnachstellung
16 : Med forstærket chassis	With HD suspension	mit verstärktem Fahrwerk
17 : Med forstærkede bremsler	With HD brakes	mit verstärktem Bremse
18 : Aluminium	Aluminium	Aluminium
B : Belgien	Belgium	Belgien
CH : Schweiz	Switzerland	Schweiz
DK : Danmark	Denmark	Dänemark
N : Norge	Norway	Norwegen
NL : Holland	Holland	Holland
S : Sverige	Sweden	Schweden
SF : Finland	Finland	Finnland
UK : Storbritanien	Great Britain	Groß Britannien

Dette katalog er udarbejdet med største omhyggelighed, dog kan vi ikke påtage os ansvar for eventuelle fejl. Bilfabrikanter og andre reservedelsnumre er kun nævnt som reference.

Every effort has been made to ensure that the information in this catalogue is correct. However we cannot accept any responsibility for errors which may occur. Vehicle manufacturers and component suppliers part numbers are listed for information only.

Alle Angaben in diesem Katalog sind mit größter Sorgfalt erstellt worden, jedoch können Ersatzansprüche auf Grund evt. Fehlangaben nicht anerkannt werden. Die verwendeten Original-Nummern der Fahrzeug-Herstellern dienen ausschließlich Vergleichszwecken.

Garanti

Garantien dækker almindelig ombytning af den defekte del, når NK har godkendt fejlen. Den defekte del må indsendes franko og reklamationer må være ledsaget af en udfyldt rapport, for at blive behandlet.

Copyright

Mekanisk, fotografisk eller anden gengivelse af dette katalog eller dele heraf er ikke tilladt.

Alle rettigheder forbeholdes.

Guarantee and compensation

The guarantee covers usual replacement of the defect part, following approval by NK of the defect. The defect part must be forwarded to us carriage paid, and a duly prepared report of the complaint must be enclosed to receive our attention.

Copyright

All rights reserved. No part of this catalogue may be reproduced, stored in a retrieval system or transmitted, in any form or by any means, electronic, mechanical, photocopying, recording or otherwise.

Information in this catalogue are subject to alteration.

Gewährleistung

Unsere Haftung für mangelhafte Ware, Bearbeitung, Montage oder andere Mängel beschränkt sich auf den Ersatz der von NK als fehlerhaft anerkannten Ware. Mit jeder Meldung eines Mangels ist uns franko die beanstandete Ware zur Prüfung zur Verfügung zu stellen. Geschieht das nicht, entfallen alle Mängelansprüche.

Copyright

Wir behalten uns alle Rechte vor. Vervielfältigung oder Mitbenutzung dieses Kataloges - auch auszugsweise - für die Erstellung eines Eigenkataloges ist ohne Zustimmung unzulässig.

Katalogangaben sind ohne Gewähr.

© NK 2004

NK varenumre der ikke fremtræder i prislisen kan være under udarbejdelse. Ring og forhør.

NK Nos. which are not in the price list might be in course of preparation. Please call and ask.

NK Nr., die nicht in der Preisliste sind, können in Ausarbeitung sein. Bitte anrufen und erfragen.





F/B

Ø

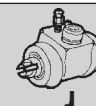
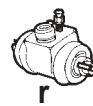

ALFA ROMEO

33

1.2/1.3/1.5 Berline	7/83-8/86	BEN	B	17,4	801002	801001
1.2/1.3/1.5 Berline	9/86-12/89	BEN	B	17,4	801005	801006
1.4/1.4 i.e./1.5 i.e. Berline	89-9/94	BEN	B	17,4	801005	801006
1.4/1.5 Sport Wagon	9/85-12/89	BEN	B	17,4	801005	801006
1.4 i.e./1.5 i.e. Sport Wagon	1/90-9/94	BEN	B	17,4	801005	801006
1.5 4x4	85-89	BEN	B	19,0	801007 U	801007 U
1.7 i.e.	8/87-89	BEN	B	17,4	801005	801006
1.7 i.e./1.7 16V, Berline, (-ABS)	1/90-9/94	BEN	B	17,4	801005	801006
1.7 i.e./1.7 16V, Sport Wagon, (-ABS)	1/90-9/94	BEN	B	17,4	801005	801006
1.7 16V 4x4, (-ABS)	1/90-9/94	BEN	B	17,4	801005	801006
Super 1.8 TD 4x2	9/86-	BEN	B	17,4	801005	801006
Super 1.8 TD Break	8/87-88	BEN	B	17,4	801005	801006

145

1.4 i.e./1.6 i.e./1.9 JTD	9/94-1/01		B	20,6	802343	802343
1.4/1.6/1.8 i.e 16V T.S/1.9 TD/2.0 16V Quadri, (-ABS)	10/94-1/01		B	22,2	802338	802338

146

1.4 i.e./1.6 i.e./1.9 JTD	12/94-1/01		B	20,6	802343	802343
1.4/1.6/1.8 i.e 16V T.S/1.9 TD/2.0 16V Quadri, (-ABS)	12/94-1/01		B	22,2	802338	802338

AR 6

1.9 D/2.4 D/2.4 TD/2.5 D	9/86-12/89	LUC	B	25,4	809936	809936
--------------------------	------------	-----	---	------	---------------	---------------

Arna

1.2/1.3/1.5 Ti	84-86	BEN	B	19,0	801007 U	801007 U
----------------	-------	-----	---	------	-----------------	-----------------



F/B

Ø

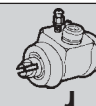
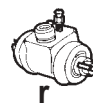

AUDI

A2 (8Z0)

1.2 TDI/1.4/1.4 Tdi (18)

2/00-

ATE

B

17,4

804739

804739

Coupe

1.6

2/81-8/81

ATE

B

14,3

804701

804701

1.6 Aut.

2/81-8/81

ATE

B

15,8

804709

804709

1.8

8/81-7/84

ATE

B

14,3

804701

804701

1.8

8/84-7/88

ATE

B

15,8

804709

804709

1.8 Aut.

8/81-7/84

ATE

B

15,8

804709

804709

1.9

10/80-8/83

ATE

B

15,8

804709

804709

2.0i

9/83-7/87

ATE

B

17,4

804706

804706

2.2i

2/81-7/88

ATE

B

17,4

804706

804706

50

Alle/All (1)

8/74-7/78

ATE

B

14,3

804701

804701

Alle/All (2)

8/74-7/78

ATE

B

17,4

804706

804706

80

1.3

8/74-3/87

ATE

B

14,3

804701

804701

1.5

72-7/74

ATE

B

15,8

804707 U

1.5 (1)

8/74-8/75

ATE

B

14,3

804701

804701

1.5 (2)

8/74-8/75

ATE

B

17,4

804706

804706

1.5 Aut.

8/74-8/75

ATE

B

17,4

804706

804706

80

1.6

9/75-8/86

ATE

B

14,3

804701

804701

1.6 51 kW.

9/86-7/91

ATE

B

15,8

804709

804709

1.6 51 kW.

9/86-7/91

LUC

B

19,0

804735

804735

1.6 51 kW, (-ABS)

1/92-

ATE

B

17,4

804706

804706

1.6 55 kW.

8/89-7/91

ATE

B

15,8

804709

804709

1.6 73 kW., (-ABS)

3/92-7/92

LUC

B

19,0

804735

804735

1.6 73 kW., (-ABS)

8/92-

B

20,6

804736

804736

1.6i CH. ->8452040209

9/73-

ATE

B

15,8

804707 U

1.6i CH. 8452040210->

-9/79

ATE

B

17,4

804706

804706

1.6i

10/79-7/82

ATE

B

15,8

804709

804709

1.6 Aut.

9/75-9/79

ATE

B

17,4

804706

804706

1.6 Aut.

10/79-8/86

ATE

B

15,8

804709

804709

1.6 Diesel

8/80-7/81

ATE

B

15,8

804709

804709

1.6 Diesel

8/81-8/86

ATE

B

14,3

804701

804701

1.6 Diesel

2/87-7/89

ATE

B

15,8

804709

804709

1.6 Diesel Aut.

8/80-8/86

ATE

B

15,8

804709

804709



F/B

Ø

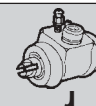
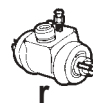

AUDI

80

1.6 Turbo-Diesel	8/81-8/86	ATE	B	15,8	804709	804709
1.6 Turbo-Diesel	4/88-7/91	LUC	B	19,0	804735	804735
1.6/1.9 TDi/2.0/2.0 16V (+ Avant), (Aluminium) (18)	9/91-1/96	FAG	B	20,6	804738	804738
1.6 Kombi	1/75-8/78	ATE	B	17,4	804706	804706
1.8	8/82-8/86	ATE	B	14,3	804701	804701
1.8 Aut.	8/82-8/86	ATE	B	15,8	804709	804709
1.8 Aut. 55 kW	9/86-7/91	LUC	B	19,0	804735	804735
1.8 Variomatic 55 kW	10/86-7/89	ATE	B	15,8	804709	804709
1.8 55 kW	8/89-7/91	ATE	B	15,8	804709	804709
1.8 66 kW	9/86-7/91	LUC	B	19,0	804735	804735
1.8i	11/82-8/86	ATE	B	15,8	804709	804709
1.9	8/81-7/83	ATE	B	15,8	804709	804709
1.9 Diesel	8/89-7/91	LUC	B	19,0	804735	804735
1.9 Turbo-Diesel 55 kW, (-ABS)	9/91-9/92	ATE	B	17,4	804706	804706
1.9 Turbo-Diesel 66 kW, (-ABS)	9/91-7/92	LUC	B	19,0	804735	804735
1.9 Turbo-Diesel 66 kW, (-ABS)	8/92-		B	20,6	804736	804736
2.0	8/83-7/84	ATE	B	15,8	804709	804709
2.0 66 kW, (-ABS)	9/91-7/92	LUC	B	19,0	804735	804735
2.0 66 kW, (-ABS)	8/92-		B	20,6	804736	804736

90

1.6 Turbo-Diesel	4/88-7/91	LUC	B	19,0	804735	804735
1.8	8/89-7/91	LUC	B	19,0	804735	804735
All/Alle (- 100 kW)	10/84-3/87	ATE	B	17,4	804706	804706

100

1.6	8/76-7/82	ATE	B	15,8	804709	804709
1.6, (-ABS)	3/92-7/93		B	20,6	804736	804736
1.8	8/82-12/90	ATE	B	17,4	804706	804706
1.9	8/80-7/84	ATE	B	17,4	804706	804706
2.0	6/76-7/78	ATE	B	17,4	804706	804706
2.0	8/84-12/90	ATE	B	17,4	804706	804706
2.0	12/90-7/93		B	20,6	804736	804736
2.0 Diesel	10/78-7/82	ATE	B	17,4	804706	804706
2.0 Diesel	9/86-12/90	ATE	B	17,4	804706	804706
2.0 Turbo-diesel	3/82-12/90	ATE	B	17,4	804706	804706
2.2	3/77-9/86	ATE	B	17,4	804706	804706



F/B

Ø

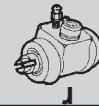
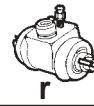

AUDI

80
 2.4 Diesel

8/89-7/93

B

20,6

804736

804736



F/B

Ø

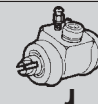
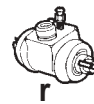

AUTOBIANCHI

A 112

Alle/All

71-12/85

O.E

B

19,0

802304

802304

Y 10

Alle/All

3/85-

B

19,0

802328

802328

BARKAS

B 1000

Alle/All

4/67-12/91

F

31,8

805901 U

805901 U

Alle/All

4/67-12/91

B

25,4

805903 U

805903 U

BEDFORD

CF Van

220 18 cwt

77-

LCH

F

22,0

809925 U

809925 U

25/35 cwt.

69-77

LCH

F

22,0

809925 U

809925 U

25/35 cwt.

69-77

LCH

B

15,7

809928

809928

250 22 cwt/250 1300 kg./280 25 cwt

77-

LCH

F

23,8

801409

801410 U

250 22 cwt/250 1300 kg./280 25 cwt

77-

LCH

B

15,7

809928

809928

340 35 cwt/350 3500 kg.

77-

LCH

F

22,0

809925 U

809925 U

340 35 cwt/350 3500 kg.

77-

LCH

B

15,7

809928

809928



F/B

Ø

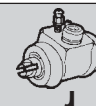
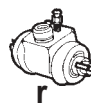

BMW

02 Series(E10)

1502 (-S)	1/75-7/77	ATE	B	15,8	801504	801504	
1600 Ti & 1600/2	9/67-11/69	ATE	B	15,8	801504	801504	
1602 (-S)	71-75	ATE	B	17,4	801503 U	801503 U	
1802 (-S)	71-75	ATE	B	15,8	801504	801504	
2002 Exc. Ti/Tii/Turbo (-S)	68-75	ATE	B	15,8	801504	801504	
2002 Turbo (-S)	1/74-7/75	ATE	B	22,2	801502 U	801502 U	

02 Series (E10)

1600-2 Cabriolet	66-71	ATE	B	17,4	801503 U	801503 U	
2002 Ti/Tii (- Turbo) (-S) Cabriolet	69-75	ATE	B	17,4	801503 U	801503 U	

02 Series Touring (E6)

1600	71-73	ATE	B	17,4	801503 U	801503 U	
1802	73-75	ATE	B	15,8	801504	801504	
2002 & 2002 Tii	5/71-7/75	ATE	B	15,8	801504	801504	

1500-2000 Series

2000 Tii	69-75	ATE	B	17,4	801503 U	801503 U	
2000 Touring (- Tii)	69-73	ATE	B	15,8	801504	801504	

2000-3.2 (E9)

2800 CS Coupe	70-72	ATE	B	22,2	801502 U	801502 U	
---------------	-------	-----	---	------	-----------------	-----------------	--

3 Series (E21)

315/316/318/318i/320/320-6/320i	6/75-3/84	ATE	B	19,0	809914	809914	
---------------------------------	-----------	-----	---	------	---------------	---------------	--

3 Series (E30)

315	9/82-10/83	ATE	B	19,0	809914	809914	
316 & 318	3/82-9/86	LUC	B	20,6	801506	801506	871510 U
316 & 318	10/86-91	LUC	B	22,2	801508	801508	
320 i	9/82-91	LUC	B	20,6	801506	801506	871510 U
324 d & 324 td	9/85-91	LUC	B	22,2	801508	801508	

3 Series Cabriolet (E30)

318 i	9/90-10/93	LUC	B	22,2	801508	801508	
320 i	4/86-10/93	LUC	B	20,6	801506	801506	

3 Series Touring (E30)

316 i & 318 i	4/89-6/94	LUC	B	22,2	801508	801508	
320 i	1/98-12/91	LUC	B	20,6	801506	801506	



F/B

Ø

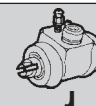
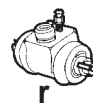

BMW

3 Series (E36)

316 i	9/90-2/98	LUC	B	23,8	801510	801510
316 i Compact	3/94-8/00	LUC	B	22,2	801511	801511
316 i Coupe	9/93-4/99	LUC	B	23,8	801510	801510
318 i/318 is/318 ti Compact	12/90-8/00	LUC	B	23,8	801510	801510
318 is Coupe	3/92-4/99	LUC	B	23,8	801510	801510
318 tds	1/95-2/98	LUC	B	23,8	801510	801510
318 tds Compact	1/95-8/00	LUC	B	22,2	801511	801511

3 Series Touring (E36)

316 i & 318 i	7/95-10/99	LUC	B	23,8	801510	801510
---------------	------------	-----	---	------	---------------	---------------

5 Series (E12)

518/520/520 i & 520/6	6/72-5/81	ATE	B	22,2	801502 U	801502 U
-----------------------	-----------	-----	---	------	-----------------	-----------------

5 Series (E28)

518/518 i, (-ABS)	6/81-12/87	ATE	B	19,0	809914	809914
520 i, (-ABS)	4/81-8/84	ATE	B	19,0	809914	809914
520 i, (-ABS)	9/84-6/90	ATE	B	20,6	801507	801507
524 td, (-ABS)	11/82-8/84	ATE	B	19,0	809914	809914
524 td, (-ABS)	9/84-3/86	ATE	B	20,6	801507	801507

5 Series (E34)

518 i, (-ABS)	8/89-9/95	ATE	B	23,8	801509	801509
---------------	-----------	-----	---	------	---------------	---------------



F/B

Ø

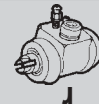
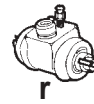

CHRYSLER

Voyager I

Alle/All

8/84-1/95

B

19,0

809302

809302

Voyager II

Alle/All

1/95-3/01

B

17,5

809301

809301

Voyager II

Alle/All

1/95-3/01

B

19,0

809304

809304



F/B

Ø

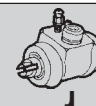
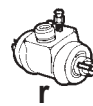

CITROËN

2 CV

4 & 6

6/70-

BEN

F

28,6

801909

801909

4 & 6

6/70-

BEN

B

17,4

801910 U

801910 U

6 (LHM)

7/81-

BEN

B

16,0

801911

801911

AMI & AMI Break

8

7/69-12/77

BEN

B

16,0

801911

801911

AX

Alle/All (6)

9/86-12/98

BEN

B

19,0

801919

801920

Alle/All (7)

9/86-12/98

BEN

B

19,0

801921

801921

1.4 Gti (180mm. Tromle/Drum/Trommel)

5/91-12/96

BEN

B

19,0

809957

809958

1.4 GTi/1.4D/1.4 4x4, ABS

5/91-12/96

BEN

B

19,0

801931

801931

Berlingo

Alle/All

7/96-

LUC

B

22,2

801929

801929

C 2

Alle/All

9/03-

LUC

B

20,6

803755

803755

C 3

Alle/All, (-ABS)

02/02-

LUC

B

19,0

801933

801934

Alle/All, ABS

02/02-

LUC

B

20,8

801935

801935

C 15

Alle/All

10/84-12/97

BEN

B

22,0

809943

809943

C 25

Alle/All (- 800 Kg. & 1800 Kg.) CH. ->73500

10/81-12/82

LUC

B

22,2

809944 U

809944 U

Alle/All (- 800 Kg. & 1800 Kg.) CH. 73501->

1/83-94

LUC

B

25,4

809936

809936

Alle/All 800 Kg.

2/89-94

LUC

B

22,2

801928

801928

Alle/All 1800 Kg.

87-94

LUC

B

27,4

809955

809955

Dyane

4 & 6

6/70-12/80

BEN

F

28,6

801909

801909

4 & 6

6/70-12/80

BEN

B

17,4

801910 U

801910 U

6

8/80-10/84

BEN

B

16,0

801911

801911

Evasion

Alle/All

6/94-7/02

BEN

B

19,0

801926

801926

Jumper

Alle/All 1000 Kg.

2/94-4/02

LUC

B

25,4

802340

802340

Alle/All 1400 Kg. (-2.5 TD)

2/94-4/02

LUC

B

25,4

802340

802340

2.5 TD 1400 Kg.

2/94-4/02

LUC

B

27,0

802341

802341

Alle/All 1800 Kg.

2/94-4/02

LUC

B

28,6

802342

802342



F/B

Ø

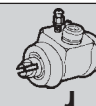
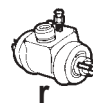

CITROËN

Jumpy

Alle/All 10/95- BEN B 19,0 801926 801926

LN

0.6 9/77-7/79 BEN B 22,0 809911 809911

0.6 7/76-8/77 LUC B 22,2 809932 809933

0.6 9/77-7/79 LUC B 22,2 809935 809935

LNA

0.6 (4) 11/78- BEN B 22,0 809911 809911

0.6 (5) 11/78- BEN B 20,6 809910 809910

0.6 11/78-6/82 LUC B 20,6 801918 801918

0.6 11/78-6/82 LUC B 22,2 809935 809935

11 E/RE 1124 cc.

7/82- BEN B 20,6 809910 809910

11 RE 7/82-7/85 LUC B 20,6 801918 801918

Mehari

Alle/All 1/72-7/77 BEN F 28,6 801909 801909

Alle/All 1/72-7/77 BEN B 17,4 801910 U 801910 U

Alle/All 7/78- BEN B 16,0 801911 801911

Saxo

1.0 & 1.1 (165 mm. Tromle/Drum/Trommel) 3/96- BEN B 19,0 803747 803748

1.1 (180 mm. Tromle/Drum/Trommel), ABS 3/96- BEN B 19,0 809957 809958

1.1 (180 mm. Tromle/Drum/Trommel), ABS 3/96- LUC B 20,6 801930 801930

CH. ->8095

1.1 (180 mm. Tromle/Drum/Trommel), ABS 3/96- LUC B 20,6 803755 803755

CH. 8096->

1.4/1.5 D & 1.6 3/96- BEN B 19,0 809957 809958

1.4/1.5 D & 1.6 3/96- LUC B 20,6 801930 801930

Visa

4ch 652 cc. (4) 9/78-3/91 BEN B 22,0 809911 809911

4ch 652 cc. (5) 7/82-3/91 BEN B 20,6 809910 809910

4ch 652 cc. 9/78-3/91 LUC B 20,6 801918 801918

4ch 652 cc. 9/78-3/91 LUC B 22,2 809935 809935

5ch 1124 cc. (4) 9/78-7/82 BEN B 22,0 809911 809911

5ch 1124 cc. (5) 9/78-7/82 BEN B 20,6 809910 809910

5ch 1124 cc. 9/78- LUC B 20,6 801918 801918

5ch 1124 cc. 9/78- LUC B 22,2 809935 809935

7ch 1219/1360 cc. 9/80-7/82 BEN B 20,6 809910 809910

10E 954 cc. 11/83- BEN B 22,0 809911 809911

11E/RE 1124 cc. 7/83- BEN B 22,0 809911 809911

1219 cc. 9/80-6/82 LUC B 22,2 809935 809935



F/B

Ø

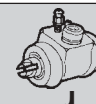
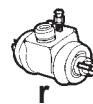

CITROËN

Visa

1360 cc.	3/82-	LUC	B	22,2	809935	809935
14 TRS 1360 cc.	7/84-	BEN	B	22,0	809911	809911
14 TRS 1360 cc.	7/84-	LUC	B	22,2	809935	809935
Chrono XT 1360 cc.	7/82-	BEN	B	22,0	809911	809911
GT 1360 cc.	7/82-7/86	BEN	B	22,0	809911	809911
GTi & Diesel	84-89	BEN	B	22,2	801925	801925
L Super E	7/82-7/83	BEN	B	22,0	809911	809911

Xsara

1.4/1.6/1.8/1.8 D/1.9 D, (-ABS) (6)	9/97-	BEN	B	20,6	803929	803930
1.4/1.6/1.8/1.9 D/1.9 TD/2.0 Hdi, ABS	9/97-	LUC	B	20,6	801930	801930
Coupe 1.8 Aut., (-ABS) (6)	2/98-8/00	BEN	B	20,6	803929	803930
Coupe 1.8 Aut., (-ABS) (6)	2/98-8/00	LUC	B	20,6	809949	809950
Coupe 1.8 Aut., ABS CH. ->08210	2/98-	LUC	B	20,6	801930	801930
Coupe 1.8 Aut., ABS CH. 08211->	-8/00	LUC	B	20,6	803755	803755
Coupe 1.9 TD, (-ABS)	2/98-9/00	LUC	B	20,6	801930	801930
Coupe 1.9 TD, ABS CH. ->08210	2/98-	LUC	B	20,6	801930	801930
Coupe 1.9 TD, ABS CH. 08211->	-9/00	LUC	B	20,6	803755	803755
Picasso 1.6/1.8 16V/2.0 Hdi	01/00-	LUC	B	22,2	801929	801929
Weekend 1.4/1.6/1.8 D/1.9 D/2.0 Hdi,	10/97-	BEN	B	20,6	801927	801927
Weekend 1.4/1.6/1.8, ABS	10/97-	BEN	B	22,0	801932	801932
Weekend 1.5 D/1.8 D/1.9 D/1.9 TD, ABS	10/97-	BEN	B	22,0	801932	801932

ZX

1.1/1.4/1.6/1.8, (-ABS)	3/91-8/92	BEN	B	20,6	801923	801924
1.1/1.4/1.6/1.8, (-ABS) (6)	9/92-	BEN	B	20,6	803929	803930
1.1/1.4/1.6/1.8, (-ABS) CH. ->5718 (6)	3/91-8/92	LUC	B	20,6	809947	809948
1.1/1.4/1.6/1.8, (-ABS) CH. 5719-> (6)	9/92-	LUC	B	20,6	809949	809950
1.4/1.6/1.8, ABS	7/95-	LUC	B	20,6	801930	801930
1.4/1.6/1.8 Break, ABS	2/94-	BEN	B	20,6	801927	801927
1.4/1.6/1.8 Break, ABS	7/95-	LUC	B	20,6	801930	801930
1.9 Diesel, (-ABS)	3/91-8/92	BEN	B	20,6	801923	801924
1.9 Diesel, (-ABS) (6)	9/92-	BEN	B	20,6	803929	803930
1.9 Diesel, (-ABS) CH. ->5718 (6)	3/91-8/92	LUC	B	20,6	809947	809948
1.9 Diesel (6)	9/92-	LUC	B	20,6	809949	809950
1.9 Diesel, ABS	7/95-	LUC	B	20,6	801930	801930
1.9 Diesel Break, ABS	7/95-	BEN	B	20,6	801927	801927



F/B

Ø

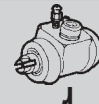
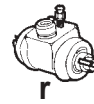

CITROËN

ZX

1.9 Turbo-Diesel, (-ABS) (6)	1/93-	BEN	B	20,6	803929	803930
1.9 Turbo-Diesel, (-ABS) (6)	9/92-	LUC	B	20,6	809949	809950
1.9 Turbo-Diesel, ABS	7/95-	LUC	B	20,6	801930	801930
1.9 Turbo-Diesel Break, ABS	7/95-	LUC	B	20,6	801930	801930



F/B

Ø

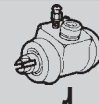
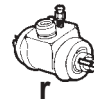

DACIA

1310

1.3

5/83-

BEN

B

803910 U

DAEWOO

Espero

Alle/All

2/95-

ATE

B

19,0

803629

803629

Lanos

1.4

5/97-

O.E

B

17,4

803628

803628

1.5 CH. ->447433

5/97-

O.E

B

17,4

803628

803628

1.5 CH. 447434->

5/97-

ATE

B

19,0

803629

803629

1.6 16V

5/97-

ATE

B

19,0

803629

803929

Matiz

Alle/All

9/98-

B

17,4

805001

805001

Nexia

Alle/All

2/95-

ATE

B

19,0

803629

803629

Nubira

1.6

97-

O.E

B

20,6

803643

803643



F/B

Ø

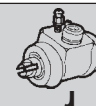
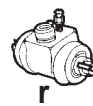

DAIHATSU

Charade (G10)

Alle/All

78-4/83

O.E

B

15,8

805102

805101

Charade (G 100)

Alle/All

2/87-

O.E

B

17,4

805105

805106

Charade (G 101)

Alle/All

2/87-

O.E

B

17,4

805105

805106

Charade (G 102)

Alle/All

9/88-

O.E

B

17,4

805105

805106

Charade (G 11)

Alle/All

4/83-

O.E

B

15,8

805103

805103

Charade (G 200)

Alle/All

1/93-

O.E

B

17,4

805105

805106

Charade (G 202)

Alle/All

1/93-

O.E

B

17,4

805105

805106

Charade (G 203)

Alle/All

6/94-

O.E

B

17,4

805105

805106

Charade (G 30)

Alle/All

10/82-

O.E

B

15,8

805103

805103

Charmant

1300 A35

11/81-7/87

O.E

B

20,6

809939

809939

1600 A40

11/76-11/81

O.E

B

19,0

809938

809938

1600 A45

12/81-9/84

O.E

B

19,0

809938

809938

1600 A60

8/83-7/87

O.E

B

19,0

809938

809938

Gran Move

Alle/All

10/96-

B

17,4

805108

805109

Hijet

Alle/All

1/96-

B

17,4

805110

805110

Rocky

Alle/All

9/89-

O.E

B

25,4

805107

805107

Terios (J1)

Alle/All

10/97-

B

20,6

805111

805112



F/B

Ø

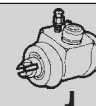
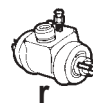

FIAT

126

Alle/All

73-96

O.E

B

19,0

802304

802304

127

Alle/All

3/71-10/82

O.E

B

19,0

802304

802304

Alle/All

10/82-86

O.E

B

19,0

802328

802328

Panorama/Diesel (147 Brazil) (11)

10/82-

O.E

B

19,0

802328

802328

128

Alle/All

69-84

O.E

B

19,0

802304

802304

131

Alle/All

10/74-8/82

O.E

B

22,2

802313 U

802313 U

132

Alle/All

4/77-81

O.E

B

22,2

802313 U

802313 U

147

Alle/All

10/76-9/82

O.E

B

19,0

802304

802304

Alle/All

10/82-

O.E

B

19,0

802328

802328

500

0.5/0.6

3/65-72

O.E

B

19,0

802304

802304

600

0.6/0.8 (D)

3/55-2/71

O.E

F

22,2

802304

802303

0.6/0.8 (D)

3/55-2/71

O.E

B

19,0

802304

802304

850

850

3/65-73

O.E

F

22,2

802303

802303

850

3/65-73

O.E

B

19,0

802304

802304

850 Coupe/Special/Spider

66-71

O.E

B

19,0

802304

802304

900

900 T/E Panorama/Pulmino

1/78-1/86

O.E

B

15,8

802324

802324

Brava/Bravo

1.2 16V, (-ABS)

12/98-10/01

LCH

B

22,2

802345

802345

1.4, ABS

6/95-

BEN

B

22,2

802344

802344

1.4

6/95-

LCH

B

22,2

802345

802345

1.6 & 1.8

6/95-

BEN

B

22,2

802344

802344

1.6 & 1.8

6/95-

LCH

B

22,2

802345

802345

1.9 Diesel, ABS

6/95-

BEN

B

22,2

802344

802344

1.9 Diesel

6/95-

LCH

B

22,2

802345

802345

1.9 TD/1.9 JTD

3/96-10/01

BEN

B

22,2

802344

802344



F/B

Ø

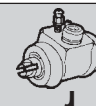
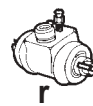

FIAT

Cinquecento

Alle/All

92-

BEN

B

19,0

802328

802328

Daily 35

F8/40 F8 (9)

79-

LCH

B

17,0

802323

802323

Daily I 35-12

Alle/All

1/90-4/96

B

19,0

802530

802530

Doblo

Alle/All

3/01-

ATE

B

20,6

802348

802348

Ducato

Alle/All 1000 Kg.

2/94-4/02

LUC

B

25,4

802340

802340

Alle/All 1400 Kg.

2/94-4/02

LUC

B

27,0

802341

802341

Alle/All 1800 Kg.

2/94-4/02

LUC

B

28,6

802342

802342

1.8 Maxi (2.5 TD)

9/86-94

LUC

B

27,4

809955

809955

Duna

Alle/All

1/87-12/91

O.E

B

19,0

802328

802328

Ducato

1.8/2.0 & Diesel

11/81-10/82

LUC

B

22,2

809944 U

809944 U

1.8/2.0 & Diesel

11/82-94

LUC

B

25,4

809936

809936

Fiorino (147)

856/903/1050 cc

11/77-10/82

O.E

B

19,0

802304

802304

903/1050 cc.

10/82-88

O.E

B

19,0

802328

802328

1050/1.3 Diesel (147 Brazil)

80-88

O.E

B

19,0

802304

802304

1.3 Diesel

2/81-10/82

O.E

B

19,0

802304

802304

1.3 Diesel

10/82-88

O.E

B

19,0

802328

802328

1.7 Diesel

01/88-

BEN

B

19,0

802328

802328

Fiorino (146 Uno)

Alle/All

5/88-12/92

BEN

B

19,0

802328

802328

Alle/All

1/93-

LUC

B

20,6

802349

802349

Marea

1.2 16V & Marea Weekend 1.2 16V

10/98-4/99

LCH

B

22,2

802345

802345

1.4 Weekend

7/96-

BEN

B

22,2

802344

802344

1.4/1.6 & 1.8 Berline

7/96-

BEN

B

22,2

802344

802344

1.6 & 1.8 Weekend

7/96-

BEN

B

20,6

802343

802343

1.9 JTD Berline

4/99-

LCH

B

22,2

802345

802345

1.9 JTD Weekend

4/99-

BEN

B

20,6

802343

802343



F/B

Ø

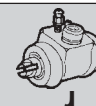
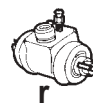

FIAT

Marea

1.9 Turbo Diesel Berline 7/96-
1.9 Turbo Diesel Weekend 7/96-

Multipla

Alle/All 4/99-

Palio

Alle/All 4/96-

Palio (Weekend)

Alle/All 4/96-

Panda

30/34/45/S 3/80-8/82 O.E B 15,8 802324 802324
30/34/45/S 9/82-7/84 O.E B 15,7 802329 802329
30/34/45/S 8/84-85 O.E B 19,0 802328 802328

45 4x4 7/83-85 O.E B 19,0 802328 802328
45 4x4 11/85- O.E B 19,0 802328 802328

750/900/1000/1100/1300D 11/85- O.E B 19,0 802328 802328

Punto

55/60/75/85/90 9/93-6/00 LCH B 20,6 802336 802336
55/60/75/85/90/131 9/93-6/00 BEN B 20,6 802337 802337

Cabrio 4/94-6/00 LCH B 20,6 802336 802336
Turbo Diesel 9/93-6/00 LCH B 20,6 802336 802336
Turbo Diesel 9/93-6/00 BEN B 20,6 802337 802337

Punto II

1.2 9/99- B 20,6 802346 802346
1.2 16V/1.8 16V/1.4HDi/1.9D/JTD 9/99- LCH B 22,0 802347 802347

Regata

Alle/All 9/83-6/90 O.E B 19,0 802328 802328

Ritmo I

60/65/75 L,CL/85 S 5/78-6/82 O.E B 17,4 802320 U 802320 U
60/65/75 L,CL/85 S 6/82-11/82 O.E B 17,4 802331 802331

105 TC 5/81-83 O.E B 17,4 802320 U 802320 U
125 TC 12/81-83 O.E B 17,4 802320 U 802320 U

Diesel 5/78-6/82 O.E B 17,4 802320 U 802320 U
Diesel 6/82-11/82 O.E B 17,4 802331 802331

Ritmo II

50/60/70/75/85 S 2/83-85 O.E B 19,0 802328 802328
105/125/130 TC 2/83-85 O.E B 19,0 802328 802328



F/B

Ø

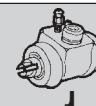
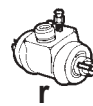

FIAT

Ritmo II

Diesel	2/83-85	O.E	B	19,0	802328	802328
Cabriolet	1/80-7/89	O.E	B	19,0	802328	802328
FL 85	4/85-88	O.E	B	19,0	802328	802328

Scudo

1.6/1.9 D/1.9 TD & 2.0 JTD	7/95-	BEN	B	19,0	801926	801926
----------------------------	-------	-----	---	------	---------------	---------------

Seicento

Alle/All	01/98-	O.E	B	19,0	802328	802328
----------	--------	-----	---	------	---------------	---------------

Siena

Alle/All	4/96-		B	19,0	802351	802351
----------	-------	--	---	------	---------------	---------------

Talento

1.9 D & 2.0	9/89-	LUC	B	22,2	801928	801928
-------------	-------	-----	---	------	---------------	---------------

Tempra

1.4/1.6 Berlina, (-ABS)	11/89-93	BEN	B	19,0	802335	802335
1.4/1.6 Aut.	11/89-93	BEN	B	17,4	802334	802334
1.4/1.6 Break, (-ABS)	4/90-93	BEN	B	17,4	802334	802334

1.4/1.6	3/93-	BEN	B	22,2	802338	802338
1.6 Break (-ABS)	3/93-	BEN	B	22,2	802338	802338
1.6 Break (-ABS)	3/93-	BEN	B	20,6	802343	802343

1.6 Selecta SX	3/93-	BEN	B	20,6	802343	802343
----------------	-------	-----	---	------	---------------	---------------

1.8, (-ABS)	11/89-93	BEN	B	17,4	802334	802334
-------------	----------	-----	---	------	---------------	---------------

1.8ie, (-ABS)	3/93-	BEN	B	20,6	802343	802343
---------------	-------	-----	---	------	---------------	---------------

1.9 Diesel DSX, (-ABS)	11/89-93	BEN	B	17,4	802334	802334
1.9 Diesel, (-ABS)	3/93-	BEN	B	22,2	802338	802338

1.9 Turbo-diesel, (-ABS)	11/89-93	BEN	B	17,4	802334	802334
1.9 Turbo-diesel, (-ABS)	3/93-	BEN	B	20,6	802343	802343

2.0 ie	10/90-8/96	BEN	B	17,4	802334	802334
--------	------------	-----	---	------	---------------	---------------

2.0 ie 4x4	3/92-3/95	BEN	B	20,6	802343	802343
------------	-----------	-----	---	------	---------------	---------------

Tipo

1.1/1.4/1.6	2/88-2/93	BEN	B	15,0	802333	802333
1.4, (-ABS)	3/93-	BEN	B	22,2	802338	802338
1.4 Selecta	2/89-2/93	BEN	B	19,0	802335	802335



F/B

Ø

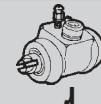
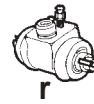

FIAT

Tipo

1.6 DOHC & 1.6 Selecta	2/88-2/93	BEN	B	17,4	802334	802334
1.6 Man., (-ABS)	3/93-	BEN	B	22,2	802338	802338
1.6 Selecta, (-ABS)	3/93-	BEN	B	20,6	802343	802343
1.7 Diesel	2/88-2/93	BEN	B	19,0	802335	802335
1.7 Diesel & 1.9 Diesel, (-ABS)	3/93-	BEN	B	22,2	802338	802338
1.8ie	4/89-2/93	BEN	B	17,4	802334	802334
1.8, (-ABS)	3/93-	BEN	B	20,6	802343	802343
1.9 Turbo Diesel, (-ABS)	2/88-2/93	BEN	B	17,4	802334	802334
1.9 Turbo Diesel, (-ABS)	3/93-	BEN	B	20,6	802343	802343
2.0 ie	3/90-4/95	BEN	B	17,4	802334	802334
Ulysse						
Alle/All	6/94-8/02	BEN	B	19,0	801926	801926
Uno						
Alle/All	83-95	O.E	B	19,0	802328	802328



F/B

Ø

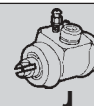
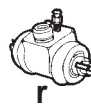

FORD

Capri

1.3 (11)	11/74-12/77	LUC	B	20,6	802516	802516	872512 U
1.6	1/74-10/74	LUC	B	17,4	802518	802518	
1.6/2.0	11/74-6/76	LUC	B	18,0	802522 U	802522 U	
1.6/2.0	7/76-86	LUC	B	17,4	802507	802507	
2.3	11/74-11/84	LUC	B	17,4	802507	802507	
2.8	1/81-86	LUC	B	19,0	809920	809920	
3.0	11/74-7/81	LUC	B	17,4	802507	802507	

Cortina

1300/1600 (+ Estate) MK II	66-70	LUC	B	17,4	802518	802518	
1300/1600 (+ Estate) MK III	70-7/71	LUC	B	20,6	802509	802509	872512 U
1300/1600 (+ Estate) MK III	8/71-74	LUC	B	19,0	802506	802506	
1300/1600 (+ Estate) MK III	74-77	BEN	B	19,0	802508	802508	
2000 (+ Estate) MK III	70-77	LUC	B	17,4	802507	802507	

Escort '81

Express 35/55/Diesel	5/81-	LUC	B	22,2	802513	802513	872561 U
----------------------	-------	-----	---	------	--------	--------	----------

Escort I

1.1/1.3 (10)	1/68-2/76	LUC	F	19,0	809922	809923	
1.1/1.3	1/68-2/76	LUC	B	19,0	809915	809915	
1.1/1.3 (3)	1/68-2/76	LUC	B		899901	899901	

Escort II

1.1/1.3 (8)	12/74-8/80	LUC	B	17,8	802537	802537	
1.1/1.3 (11)	12/74-8/80	LUC	B	20,6	802516	802516	872512 U
1.3 70 HK	12/74-11/75	LUC	B	17,4	802507	802507	
1.3 70 HK	12/75-8/80	LUC	B	19,0	809920	809920	
1.6 RS	1/75-8/80	LUC	B	17,4	802507	802507	
RS 2000	3/73-8/80	LUC	B	19,0	809920	809920	

Escort III

1.1/1.3	9/80-1/83	LUC	B	19,0	802506	802506	
1.1/1.3	2/83-12/85	LUC	B	17,4	802507	802507	
1.1 Turnier/1.3 Turnier	9/80-12/85	LUC	B	22,2	802513	802513	872561 U
1.3/1.6 LX	83-85	LUC	B	17,4	802507	802507	



F/B

Ø

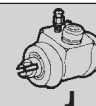
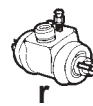

FORD

Escort III

1.6	9/80-1/83	LUC	B	19,0	802506	802506	
1.6	2/83-1/86	LUC	B	17,4	802507	802507	
1.6 Diesel	2/84-12/85	LUC	B	17,4	802507	802507	
1.6 Turnier	9/80-12/85	LUC	B	22,2	802513	802513	872561 U
RS 1600 i	3/82-9/82	LUC	B	19,0	802506	802506	
RS 1600 i	10/82-12/85	LUC	B	17,4	802507	802507	
RS Turbo 1.6	11/84-12/85	LUC	B	17,4	802507	802507	
XR3i 1.6	12/81-9/82	LUC	B	19,0	802506	802506	
XR3i 1.6	10/82-4/83	LUC	B	17,4	802507	802507	
XR3i 1.6	5/83-12/85	LUC	B	17,4	802507	802507	

Escort IV

Alle/All, (-ABS)	2/86-7/90	LUC	B	19,0	802506	802506	
Alle/All, ABS	2/86-7/90	LUC	B	22,2	802513	802513	872561 U
Van & St. car	2/86-7/90	LUC	B	22,2	802513	802513	872561 U

Escort V/VI

1.1/1.3/1.4, (-ABS)	8/90-95	LUC	B	20,6	802552	802552	
1.6/1.8/1.8 Diesel, (-ABS)	8/90-95	LUC	B	19,0	802506	802506	
1.1/1.3/1.4/1.6/1.8 & 1.8D, ABS	8/90-95	LUC	B	22,2	802513	802513	
1.3 St. car, (-ABS)	8/90-95	LUC	B	19,0	802506	802506	
1.4 Cabrio/St. car/Aut., (-ABS)	8/90-95	LUC	B	19,0	802506	802506	

Escort V

1.8 16V XR3i, (-ABS)	2/92-12/92	LUC	B	19,0	802506	802506	
----------------------	------------	-----	---	------	---------------	---------------	--

Escort VII

1.3/1.4GLX, GT, (-ABS)	2/95-	LUC	B	20,6	802552	802552	
1.4/1.6i 16V/1.8Si/1.8D,TD,TDi, (-ABS)	2/95-	LUC	B	19,0	802506	802506	
Alle/All, ABS	2/95-	LUC	B	22,2	802513	802513	

Fiesta I

1.0/1.1	6/76-7/83	BEN	B	15,8	802524	802524	
1.0/1.1/1.3	6/76-7/83	BEN	B	17,4	802523	802523	
XR2	10/81-7/83	BEN	B	19,0	802558	802558	

Fiesta II

1.0/1.1/1.3/1.4	8/83-4/89	BEN	B	17,4	802539	802539	
1.6 Diesel	2/84-4/89	BEN	B	15,0	802555	802555	
XR2	2/84-4/89	BEN	B	20,6	802556	802556	



F/B

Ø

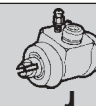
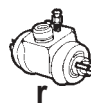

FORD

Fiesta III

1.1/1.3/1.4/1.8 D, (-ABS)	2/89-95	BEN	B	17,4	802549	802549	
1.1/1.3/1.4/1.6/1.8 D, ABS	2/89-95	BEN	B	22,2	802550	802550	
1.6 XR2i, (-ABS)	5/89-12/92	BEN	B	19,0	802557	802557	
1.6 XR2i, ABS	5/89-12/92	BEN	B	22,2	802550	802550	
1.8 16V XR2i, (-ABS)	1/92-12/94	BEN	B	19,0	802557	802557	
1.8 16V XR2i, ABS	1/92-12/94	BEN	B	22,2	802550	802550	
1.8i 16V, (-ABS)	1/92-12/94	BEN	B	19,0	802557	802557	
1.8i 16V, ABS	1/92-12/94	BEN	B	22,2	802550	802550	

Fiesta IV

Alle/All, Man.	8/95-	LUC	B	17,4	802507	802507	
Alle/All, Aut.	8/95-	LUC	B	22,2	802506	802506	

Fiesta V

Alle/All	11/01-		B	19,0	802567	802567	
----------	--------	--	---	------	---------------	---------------	--

Fiesta Courier

Alle/All	8/91-	LUC	B	22,2	802513	802513	
Alle/All, ABS	8/91-	BEN	B	22,2	802550	802550	

Focus

1.4i 16V/1.6 16V/1.8 16V Turnier, (-ABS)	10/98-	LUC	B	22,2	802513	802513	
1.4i 16V/1.6i 16V/1.8i 16V/1.8TDI, ABS	10/98-	LUC	B	20,6	802509	802509	
1.8 TD, (-ABS)	10/98-	LUC	B	19,0	802506	802506	
1.8 TD Turnier/ 2.0 16V, (-ABS)	10/98-	LUC	B	20,6	802552	802552	
1.8 TD Turnier, ABS	10/98-	LUC	B	20,6	802509	802509	

Granada

1.6	8/81-7/82	LUC	B	22,2	802513	802513	872561 U
1.7	2/75-7/77	LUC	B	20,6	802509	802509	872512 U
1.7 (S)	2/75-7/77	LUC	B	17,4	802507	802507	
1.7	8/77-7/81	LUC	B	19,0	802506	802506	
1.7 (DK,N,S,SF)	8/77-4/79	LUC	B	20,6	802509	802509	872512 U
1.7 Turnier	2/75-7/81	LUC	B	19,0	802506	802506	
1.7 Turnier	5/79-7/81	LUC	B	20,6	802509	802509	872512 U
1.7 Turnier (DK,N,S,SF)	8/77-4/79	LUC	B	20,6	802509	802509	872512 U
2.0	2/75-4/79	LUC	B	19,0	802506	802506	
2.0	5/79-7/81	LUC	B	20,6	802509	802509	872512 U
2.0	8/81-3/85	LUC	B	22,2	802513	802513	872561 U
2.0 (DK,N,S,SF)	8/77-4/79	LUC	B	20,6	802509	802509	872512 U
2.0 (DK)	5/79-11/79	LUC	B	19,0	802506	802506	
2.0 (S)	2/75-7/77	LUC	B	17,4	802507	802507	
2.0 (SF)	5/79-7/81	LUC	B	19,0	802506	802506	



F/B

Ø

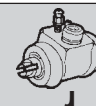
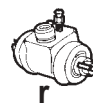

FORD

Granada

2.0 Turnier	2/75-7/81	LUC	B	19,0	802506	802506	
2.0 Turnier	8/81-3/85	LUC	B	22,2	802513	802513	872561 U
2.0 Turnier	8/79-7/81	LUC	B	20,6	802509	802509	872512 U
2.0 Turnier (DK,N,S,SF)	8/77-4/79	LUC	B	20,6	802509	802509	872512 U
2.1 Diesel	8/81-7/82	LUC	B	22,2	802513	802513	872561 U
2.1 Diesel	3/78-4/79	LUC	B	19,0	802506	802506	
2.1 Diesel (DK)	5/79-11/79	LUC	B	19,0	802506	802506	
2.1 Diesel (DK,N,S,SF)	3/78-4/79	LUC	B	20,6	802509	802509	872512 U
2.1 Diesel (SF)	5/79-7/81	LUC	B	19,0	802506	802506	
2.3	1/74-4/79	LUC	B	19,0	802506	802506	
2.3	5/79-7/81	LUC	B	20,6	802509	802509	872512 U
2.3	8/81-3/85	LUC	B	22,2	802513	802513	872561 U
2.3 (DK)	5/79-11/79	LUC	B	19,0	802506	802506	
2.3 (DK,N,S,SF)	8/77-4/79	LUC	B	20,6	802509	802509	872512 U
2.3 (S)	11/74-7/77	LUC	B	17,4	802507	802507	
2.3 (SF)	5/79-7/81	LUC	B	19,0	802506	802506	
2.3 Turnier	8/81-3/85	LUC	B	22,2	802513	802513	872561 U
2.3 Turnier	1/74-7/81	LUC	B	19,0	802506	802506	
2.3 Turnier	5/79-7/81	LUC	B	20,6	802509	802509	872512 U
2.3 Turnier (DK,N,S,SF)	8/77-4/79	LUC	B	20,6	802509	802509	872512 U
2.5 Diesel	8/82-3/85	LUC	B	22,2	802513	802513	872561 U
2.5 Diesel Turnier	8/82-3/85	LUC	B	22,2	802513	802513	872561 U
2.6	1/74-7/77	LUC	B	22,2	802513	802513	872561 U
2.6 (S)	11/74-7/77	LUC	B	17,4	802507	802507	
2.6 Turnier	1/74-7/77	LUC	B	22,2	802513	802513	872561 U
2.6 Turnier (S)	11/74-7/77	LUC	B	17,4	802507	802507	
2.8	5/79-7/81	LUC	B	20,6	802509	802509	872512 U
2.8	8/81-3/85	LUC	B	22,2	802513	802513	872561 U
2.8	1/77-4/79	LUC	B	19,0	802506	802506	
2.8 (DK)	5/79-11/79	LUC	B	19,0	802506	802506	
2.8 (DK,N,S,SF)	8/77-4/79	LUC	B	20,6	802509	802509	872512 U
2.8 (S)	1/77-7/77	LUC	B	17,4	802507	802507	
2.8 (SF)	5/79-7/81	LUC	B	19,0	802506	802506	
2.8 Turnier	8/77-7/81	LUC	B	19,0	802506	802506	
2.8 Turnier	8/81-3/85	LUC	B	22,2	802513	802513	872561 U
2.8 Turnier	5/79-7/81	LUC	B	20,6	802509	802509	872512 U
2.8 Turnier (DK,N,S,SF)	8/77-4/79	LUC	B	20,6	802509	802509	872512 U
3.0	1/74-7/77	LUC	B	19,0	802506	802506	
3.0 (S)	11/74-7/77	LUC	B	17,4	802507	802507	
3.0 Turnier	1/74-7/77	LUC	B	19,0	802506	802506	
3.0 Turnier (S)	11/74-7/77	LUC	B	17,4	802507	802507	



F/B

Ø

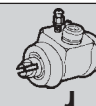
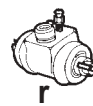

FORD

			F/B	Ø	R	J	
Ka							
Alle/All	9/96-	LUC	B	17,4	802507	802507	
Alle/All	8/02-		B	19,0	802567	802567	
Maverick							
Alle/All, (2 Dørs/Door/Türig)	2/93-8/96	O.E	B	22,2	802247	802247	
Alle/All, (4 Dørs/Door/Türig)	2/93-8/96	O.E	B	23,8	802248	802248	
Mondeo							
1.6i/1.8i/1.8 TD	1/93-5/94	LUC	B	20,6	802561	802561	
1.6i/1.8i/1.8 TD	6/94-11/00	LUC	B	22,2	802566	802566	
1.6/1.8/2.0/1.8 TD Stationcar/Van	1/93-11/00	LUC	B	22,2	802562	802562	
2.0	1/93-11/00	LUC	B	20,6	802561	802561	
Orion I							
Alle/All	7/83-3/86	LUC	B	17,4	802507	802507	
Orion II							
Alle/All	12/85-7/90	LUC	B	19,0	802506	802506	
Alle/All	12/85-7/90	LUC	B	22,2	802513	802513	872561 U
Orion III							
Alle/All	7/90-12/93	LUC	B	20,6	802552	802552	
Alle/All (-ABS)	7/90-12/93	LUC	B	19,0	802506	802506	
Alle/All ABS	7/90-12/93	LUC	B	22,2	802513	802513	872561 U
Puma							
1.4 16V & 1.7 16V	3/97-	LUC	B	19,0	802506	802506	
Sierra							
1.3/1.6	8/82-12/86	BEN	B	20,6	802536	802536	
1.6	1/87-	BEN	B	22,0	802551	802551	
1.6	1/87-	LUC	B	20,6	802509	802509	872512 U
1.6 Turnier	8/82-12/86	LUC	B	20,6	802509	802509	872512 U
1.6 Turnier	1/87-	LUC	B	22,2	802513	802513	872561 U
1.8	10/82-	LUC	B	20,6	802509	802509	872512 U
1.8 Turnier	8/85-12/86	LUC	B	20,6	802509	802509	872512 U
1.8 Turnier	1/87-	LUC	B	22,2	802513	802513	872561 U
2.0, (-ABS)	1/87-2/93	LUC	B	20,6	802552	802552	872512 U
2.0	8/82-	LUC	B	20,6	802509	802509	872512 U
2.0 i S	2/85-	LUC	B	20,6	802509	802509	872512 U
2.0 Turnier	10/85-12/86	LUC	B	20,6	802509	802509	872512 U
2.0 Turnier	1/87-	LUC	B	22,2	802513	802513	872561 U



F/B

Ø

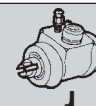
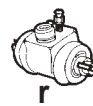

FORD

Sierra

2.0i S Turnier	8/85-12/86	LUC	B	20,6	802509	802509	872512 U
2.0i S Turnier	1/87-	LUC	B	22,2	802513	802513	872561 U
2.3	8/82-	LUC	B	20,6	802509	802509	872512 U
2.3 Diesel	8/82-	LUC	B	20,6	802509	802509	872512 U
2.3 Diesel Turnier	8/85-12/86	LUC	B	20,6	802509	802509	872512 U
2.3 Diesel Turnier	1/87-	LUC	B	22,2	802513	802513	872561 U
2.8 XR4i	1/83-1/85	LUC	B	22,2	802513	802513	872561 U
P 100 Pick up	88-	LCH	B	23,8	802544	802545	

Taurus

17M P3	62-64	ATE	B	17,4	802505	802505	
17M P3 Kombi	62-64	ATE	B	19,0	809914	809914	
17M/20M/Turnier	65-71	ATE	B	17,4	802505	802505	
20M RS/26M	68-71	ATE	B	17,4	802505	802505	
1.3/1.6	1/74-7/74	LUC	B	19,0	802506	802506	
1.3/1.6	8/74-7/82	BEN	B	19,0	802508	802508	
1.6 HD	1/74-12/75	LUC	B	17,4	802507	802507	
1.6 HD	1/76-7/82	LUC	B	19,0	802506	802506	
1.3 Turnier	1/74-7/74	LUC	B	19,0	802506	802506	
1.3 Turnier	8/74-7/82	BEN	B	19,0	802508	802508	
1.3 Turnier HD	1/74-12/75	LUC	B	17,4	802507	802507	
1.3 Turnier HD	1/76-7/82	LUC	B	19,0	802506	802506	
1.6 Turnier	1/74-7/74	LUC	B	19,0	802506	802506	
1.6 Turnier	8/74-7/82	BEN	B	19,0	802508	802508	
1.6 Turnier HD	1/74-12/75	LUC	B	17,4	802507	802507	
1.6 Turnier HD	1/76-7/82	LUC	B	19,0	802506	802506	
2.0/2.3	1/74-7/82	LUC	B	17,4	802507	802507	
2.0 Turnier	8/74-7/82	LUC	B	17,4	802507	802507	
2.3 Turnier	8/80-7/82	LUC	B	17,4	802507	802507	

Transit

100	76-4/80	LCH	B	20,3	802531	802531	879905 U
100	4/80-86	LCH	B	20,3	802531	802531	879905 U
100 Bus/Kombi/Van	86-91	LCH	B	20,3	802540	802540	
100 Van	86-91	LCH	B	22,2	802541	802542	



F/B

Ø

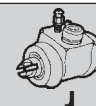
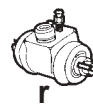

FORD

Transit

100L	76-4/80	LCH	B	20,3	802531	802531	879905 U
100L	4/80-86	LCH	B	20,3	802531	802531	879905 U
100L	86-87	LCH	B	22,2	802541	802542	
100L	88-91	LCH	B	20,3	802559	802560	
115 Bus/Kombi	7/76-	LCH	B	20,3	802531	802531	879905 U
120 Kombi	76-86	LCH	B	20,3	802531	802531	879905 U
120 Bus/Kombi/Van	86-91	LCH	B	20,3	802540	802540	
120 Chassis	86-91	LCH	B	22,2	802543	802543	
125 Kombi	5/72-4/78	LCH	F	22,2	809926	809927	
130 Bus/Kombi/Van	72-4/80	LCH	F	22,2	809926	809927	
130 Bus/Kombi/Van	4/80-86	LCH	F	22,2	809926	809927	
130 Kombi/Van	86-89	LCH	B	23,8	802544	802545	
130 Kombi/Van	5/89-	LCH	B	20,3	802559	802560	
150 Bus/Kombi/Van	5/72-86	LCH	F	22,2	809926	809927	
160	76-85	LCH	B	25,0	802532	802533	
160 Bus/Kombi/Van	86-91	LCH	B	25,4	802546	802547	
160 Kombi	86-91	LCH	B	23,8	802544	802545	
175 Bus/Kombi/Van	70-76	LCH	F	22,2	809926	809927	
175 Bus/Kombi/Van	76-86	LCH	F	22,2	809926	809927	
1750 Van 35 cwt.	65-9/68	LCH	F	22,0			
1750 Van 35 cwt.	9/68-12/70	LCH	B	19,0	802530	802530	
190	9/76-85	LCH	B	25,0	802532	802533	
190 Bus/Kombi/Van	86-91	LCH	B	25,4	802546	802547	
190 Benzin/Petrol & Diesel	9/91-	BEN	B	25,4	802565	802565	
80 Bus/Kombi/Van	86-91	LCH	B	20,3	802540	802540	
80-100L, S 115 & 120 E	9/91-	BEN	B	22,2	802563	802563	
80-120, 130, 150S & 150L	9/91-	BEN	B	20,6	802564	802564	
2.0 DI/2.4 DI	3/00-		B	25,4	802568	802568	
2.4 TDE	11/01-	BEN	B	25,4	802565	802565	



F/B

Ø

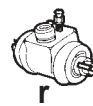

I

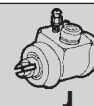

J



FORD USA

Maverick

2.4i & 2.7 TD, (2 Dørs/Door/Türig)	2/93-8/96	O.E	B	22,2	802247	802247
2.4i & 2.7 TD, (2 Dørs/Door/Türig)	9/96-4/98	O.E	B	23,8	802248	802248
2.4i & 2.7 TD, (4 Dørs/Door/Türig)	2/93-8/96	O.E	B	23,8	802248	802248

HANOMAG

Hanomag

F 25 CH. 6400229->	-1971	ATE	B	22,0	809906	809906
F 30 CH. 6600417->	-1971	ATE	B	22,0	809906	809906
F 35 CH. 6800096->	-1971	ATE	B	22,0	809906	809906
F 20 (CH, S)	1972	ATE	B	22,0	809906	809906
F 20/30/35	1972	ATE	B	22,0	809906	809906
F 20/25/30/35 L/DL (-S)	73-74	ATE	B	22,0	809906	809906
F 20/25/30/35 L/DL	73-74	ATE	F	22,0	809907	809907
L 406/DG/407 D/408 DG/508 DG	67-	ATE	B	22,0	803307	803307
L 406/DG/407 D/408 DG/508 DG	67-	ATE	F	22,0	803307	803307



F/B

Ø

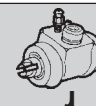
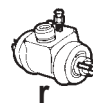

HONDA

Accord

1600, SJ, (-S)	77-78	O.E	B	17,4	802601 U	802601 U
1600, SJ, (-S)	79-81	O.E	B	19,0	802605 U	802605 U

1600, SY, Hatchback & Saloon	82-83	O.E	B	19,0	802608	802608
------------------------------	-------	-----	---	------	---------------	---------------

1600, AC, Sedan & Hatchback	84-85	O.E	B	19,0	802608	802608
-----------------------------	-------	-----	---	------	---------------	---------------

1600, CA4, Sedan	86-88	O.E	B	20,6	802606	802606
------------------	-------	-----	---	------	---------------	---------------

1800, AD, Sedan & Hatchback	84-85	O.E	B	19,0	802608	802608
-----------------------------	-------	-----	---	------	---------------	---------------

1800, CB1, Sedan	90-91	O.E	B	19,0	802617	802618
------------------	-------	-----	---	------	---------------	---------------

2000, CA5, Sedan & Hatchback	86-88	O.E	B	20,6	802606	802606
------------------------------	-------	-----	---	------	---------------	---------------

2000, CB3, Sedan	90-92	O.E	B	19,0	802617	802618
------------------	-------	-----	---	------	---------------	---------------

2200, CB7	90-92	O.E	B	19,0	802617	802618
-----------	-------	-----	---	------	---------------	---------------

Aerodeck

2000, CA5	86-	O.E	B	20,6	802606	802606
-----------	-----	-----	---	------	---------------	---------------

Civic

1200	72-76	O.E	B	17,4	802601 U	802601 U
------	-------	-----	---	------	-----------------	-----------------

1200	76-80	O.E	B	15,9	802602	802602
------	-------	-----	---	------	---------------	---------------

1200, AL/AM, Sedan	84-87	O.E	B	19,0	802611	802612
--------------------	-------	-----	---	------	---------------	---------------

1200, EC/ED, Sedan	88-89	O.E	B	19,0	802611	802612
--------------------	-------	-----	---	------	---------------	---------------

1200, EC/ED	90-91	O.E.	B	19,0	802613	802614
-------------	-------	------	---	------	---------------	---------------

1300, SL/SS/WC, Hatchback	80-81	O.E	B	17,4	809951 U	
---------------------------	-------	-----	---	------	-----------------	--

1300, SL/SS/SP/, Sedan & Hatchback	82-83	O.E	B	19,0	802609	802609 U
------------------------------------	-------	-----	---	------	---------------	-----------------

1300, AG/AJ, Sedan	84-87	O.E	B	19,0	802611	802612
--------------------	-------	-----	---	------	---------------	---------------

1300, EC, Sedan	88-89	O.E	B	19,0	802611	802612
-----------------	-------	-----	---	------	---------------	---------------

1300, EC, Sedan	90-91	O.E	B	19,0	802613	802614
-----------------	-------	-----	---	------	---------------	---------------

1300, EG	92-	O.E	B	19,0	802615	802616
----------	-----	-----	---	------	---------------	---------------

1300, WC, Wagon	82-83	O.E	B	17,4	809951 U	
-----------------	-------	-----	---	------	-----------------	--

1400, EC, Sedan	88-89	O.E	B	19,0	802611	802612
-----------------	-------	-----	---	------	---------------	---------------

1400, EC, Sedan	90-91	O.E	B	19,0	802613	802614
-----------------	-------	-----	---	------	---------------	---------------

1500	75-80	O.E	B	17,4	802601 U	802601 U
------	-------	-----	---	------	-----------------	-----------------

1500, AH/AK, Sedan	84-87	O.E	B	19,0	802611	802612
--------------------	-------	-----	---	------	---------------	---------------

1500, ED, Sedan	88-89	O.E	B	19,0	802611	802612
-----------------	-------	-----	---	------	---------------	---------------

1500, ED, Sedan	90-91	O.E	B	19,0	802613	802614
-----------------	-------	-----	---	------	---------------	---------------

1500, EG	92-	O.E	B	19,0	802615	802616
----------	-----	-----	---	------	---------------	---------------

1600, ED/EE, Sedan	88-89	O.E	B	19,0	802611	802612
--------------------	-------	-----	---	------	---------------	---------------

1600, ED/EE, Sedan	90-91	O.E	B	19,0	802613	802614
--------------------	-------	-----	---	------	---------------	---------------

1600, DOHC, EG	92-	O.E	B	19,0	802615	802616
----------------	-----	-----	---	------	---------------	---------------

1600, SOHC, EH	92-	O.E	B	19,0	802615	802616
----------------	-----	-----	---	------	---------------	---------------



F/B

Ø

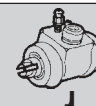
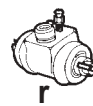

HONDA

Civic

Coupe 1.5i Lsi, EJ2 1/94-12/96 O.E B 19,0 802615 802616
Coupe 1.6i Vtec, EJ 1/94-11/95 O.E B 19,0 802613 802614

CRX 1500, AF, Coupe 84-87 O.E B 19,0 802611 802612

CRX 1600, AS, Coupe 86-87 O.E B 19,0 802611 802612

CRX 1.6 Esi, EH6, (-ABS) 3/92-12/98 O.E B 19,0 802613 802614

Shuttle 1400, EE1/2, Hatchback 88-89 O.E B 19,0 802607 802607

Shuttle 1500, EE1/2, Hatchback 88-89 O.E B 19,0 802607 802607

Shuttle 1600, AN, Hatchback 84-87 O.E B 19,0 802611 802612

Shuttle 1600, AR, Hatchback, 4 WD 85-87 O.E B 19,0 802611 802612

Shuttle 1600, EE4, Hatchback, 4 WD 1988 O.E B 19,0 802607 802607

1.4i, MA8 9/94-1/97 O.E B 19,0 802615 802616

1.4i, EJ9 11/95-2/01 O.E B 19,0 802613 802614

1.5i Vtec-E, MA9, (-ABS) 9/94-12/95 O.E B 19,0 809953 809954

1.5i, EK3 11/95-2/01 O.E B 19,0 802615 802616

1.6i, EK1 11/95-2/01 O.E B 19,0 802613 802614

Concerto

Alle/All 8/89-3/95 O.E B 19,0 809953 809954

HR-V

Alle/All 3/99- O.E B 19,0 802613 802614

Jazz (AA)

1.2 10/83-10/86 O.E B 19,0 802609 802609 U

Prelude I

1.6 11/78- O.E B 17,4 809951 U

Quintet

1600, SU 80-83 O.E B 17,4 809951 U



F/B

Ø

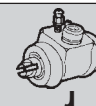
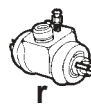

HYUNDAI

Accent (X-3)

Alle/All

10/94-1/00

O.E

B

19,0

803401

803402

Accent (LC)

Alle/All

1/00-

O.E

B

19,0

803413

803414

Atos

1.0

2/98-

B

803411

803412

Coupe

1.6/1.6i 16V, RD

12/96-4/02

O.E.

B

19,0

803405

803406

H 100

2.5 Diesel, FDX

7/93-

O.E

B

20,6

803403

803404

Lantra I

Alle/All

10/90-11/95

O.E.

B

19,0

803405

803406

Lantra II

1.5/1.6/1.8

11/95-

O.E.

B

19,0

803405

803406

Pony

Alle/All

10/89-6/90

BEN

B

20,6

803409

803409

Alle/All

7/90-

MAN

B

20,6

803407

803408

S Coupe

Alle/All

2/90-6/92

BEN

B

20,6

803409

803409

Alle/All

7/92-5/96

MAN

B

20,6

803407

803408

Sonata

Alle/All

95-

O.E.

B

19,0

803405

803406



F/B

Ø

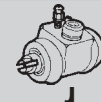
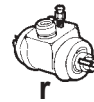

ISUZU

Campo(TFR/TFS)

Alle/All

1/83-12/90

O.E

B

25,4

801433

801433

KB/KBD

Alle/All

1/83-12/91

O.E

B

25,4

801433

801433

Trooper

2.0 G200Z/2.0 D C223

81-83

O.E

B

25,4

801433

801433

2.0 UBS 13

84-

O.E

B

22,2

801432

801432

2.2 D/2.3 TD UBS 52

83-

O.E

B

22,2

801432

801432

2.3 UBS 16

86-

O.E

B

22,2

801432

801432

2.6i, UBS 17

10/87-10/88

O.E

B

25,4

801433

801433

2.8 TD, UBS55

10/87-10/88

O.E

B

25,4

801433

801433

KIA

Pregio

Alle/All

10/97-

B

19,0

803503

803504

Sephia

Alle/All

9/93-

19,0

803501

803501

Sportage

Alle/All

4/94-6/97

B

20,6

803502

803502

Alle/All

6/97-

B

20,6

803505

803505



F/B

Ø

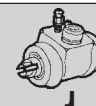
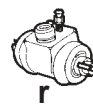

LADA

110/111/112

1.5&1.5 16V

1/95-

O.E

B

20,6

802306

802306

1200-1600

1200/1300/1500/1600

1/70-12/78

O.E

B

19,0

802304

802304

1200/1300/1500/1600

78-

O.E

B

20,6

802321

802321

1200/1300/1500/1600 (15)

78-

O.E

B

20,6

802306

802306

Niva

1600

12/76-3/95

O.E

B

20,6

802321

802321

Nova

1200/1300/1500

5/81-

O.E

B

20,6

802306

802306

Samara

1100/1300/1500

1/86-

O.E

B

20,6

802306

802306

LANCIA

A112

0.9/1.0

3/81-10/82

O.E

B

19,0

802304

802304

0.9/1.0

11/82-12/86

O.E

B

19,0

802328

802328

Dedra

Alle/All

8/89-7/99

O.E

B

19,0

802335

802335

Delta I

1.3/1.5 CH. ->229445

9/79-8/92

O.E

B

17,4

802320 U

802320 U

1.3/1.5/1.9 Turbo Diesel CH. 229446-262990

9/79-8/92

O.E

B

17,4

802331

802331

1.3/1.5/1.9 Turbo Diesel CH. 262991->

9/79-8/92

O.E

B

19,0

802328

802328

Delta II

Alle/All

6/93—8/99

BEN

B

22,2

802338

802338

Prisma

1.3/1.5 CH. ->3032272

1/83-

O.E

B

17,4

802331

802331

1.3/1.5 CH. 3032273->

-2/92

O.E

B

19,0

802328

802328

Diesel & Turbo Diesel

1/83-2/92

O.E

B

19,0

802328

802328

Y (840A)

1.1/1.2/1.2 16V

3/96-

BEN

B

20,6

802337

802337

1.1/1.2/1.2 16V

3/96-

LCH

B

20,6

802336

802336

1.4 12V

3/96-12/98

BEN

B

20,6

802337

802337

1.4 12V

3/96-12/98

LCH

B

20,6

802336

802336

Y10 (156)

Alle/All

3/85-12/95

O.E

B

19,0

802328

802328



F/B

Ø

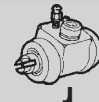
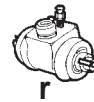

LANCIA

Zeta

Alle/All

5/95-9/02

BEN

B

19,0

801926

801926

LANDROVER

Freelander

1.8 16V/2.0 Di

2/98-

LUC

B

20,6

802552

802552



F/B

Ø

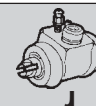
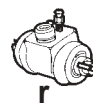

MAZDA

1000/1300

1.0 1/75-1/77 O.E B 19,0 803205 803205

1300

Alle/All 70-7/75 O.E B 19,0 803201 U 803201 U

Alle/All 7/75-8/76 O.E B 17,0 803202 U 803202 U

1600/1800

Alle/All 69-73 O.E B 17,0 803202 U 803202 U

121 (DA&DB)

Alle/All 10/87-3/96 O.E B 15,9 803230 803230

121 (JASM,JBSM)

Alle/All, Man. 3/96- O.E B 17,4 802507 802507

Alle/All, Aut. 3/96- O.E B 19,0 802506 802506

323 (FA)

Alle/All 1/77- O.E B 19,0 803205 803205

323 Wagon (FA)

Alle/All 5/78- O.E B 19,0 803217

323 (BD)

Alle/All 11/80- O.E B 17,4 803215 803215

323 (BF)

Alle/All 8/85- O.E B 17,4 803228 803228

323 Wagon (BW)

Alle/All 5/86- O.E B 17,4 803228 803228

323 (BG)

Alle/All 8/89- O.E B 17,4 803227 803227

323 F (BG)

Alle/All 8/89- O.E B 17,4 803227 803227

323 (BA)

Alle/All 7/94- O.E B 19,0 803229 803229

323 F (BA)

Alle/All 7/94- O.E B 19,0 803229 803229

323 (BJ)

Alle/All 9/98- O.E B 17,4 803227 803227

323 F (BJ)

Alle/All 9/98- O.E B 17,4 803227 803227



F/B

Ø

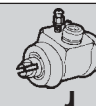
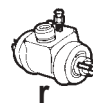

MAZDA

616

Alle/All

6/73-2/78

O.E

B

19,0

803201 U

803201 U

626 (CB)

Alle/All

5/79-12/80

O.E

B

20,6

803206 U

803207

626 (GC)

Alle/All

11/82-9/87

O.E

B

19,0

803221

803221

626 (GD)

Alle/All

6/87-8/91

O.E

B

17,4

803227

803227

626 (GE)

Alle/All

8/94-4/97

O.E

B

17,4

803227

803227

626 (GF)

Alle/All

5/97-12/99

O.E

B

17,4

803227

803227

626 (GV)

Alle/All

9/89-11/96

O.E

B

17,4

803227

803227

818

Alle/All

71-10/75

O.E

B

17,0

803202 U

803202 U

929

Alle/All

7/75-4/78

O.E

B

20,6

803206 U

803207

929 L

Alle/All

4/78-9/80

O.E

B

22,0

803209 U

B-Serie

1.8

10/81-84

O.E

B

22,2

803220 U

803220 U

2.2

1/85-10/90

O.E

B

19,0

803223 U

Demio

Alle/All

8/98-

O.E

B

17,4

803231

803231

E 2000/E 2200

Alle/All

1/84-

O.E

B

19,0

803223 U

Alle/All (9)

1/84-

O.E

B

17,4

803225

803226

MX3

Alle/All

7/91-

O.E

B

17,4

803227

803227



F/B

Ø

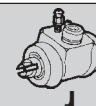
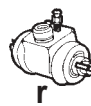

MERCEDES-BENZ

A-Klasse

Alle/All CH. ->J078973

7/97-

LUC

B

19,0

803316

803316

Alle/All CH. J078974->

7/97-

LUC

B

17,4

803315

803315

GD (W460)

Alle/All

3/79-7/93

ATE

B

17,5

803314

803314

GD (W461)

Alle/All

2/90-

ATE

B

17,5

803314

803314

GD (W463)

Alle/All

9/89-

ATE

B

17,5

803314

803314

MB 100 Series

Alle/All

2/88-2/96

LUC

B

25,4

803313

803313

T1 (601/602)

Alle/All

4/77-2/96

FAG

B

18,8

803312

803312

BM 605/606

L 206 DG/L 306 DG

ATE

F

22,0

809907

809907

L 206 DG/L 306 DG

10/72-77

ATE

B

22,0

809906

809906

L 207/L 307

10/72-77

ATE

B

22,0

809906

809906

L 207/L 307

ATE

F

22,0

809907

809907

BM 607/608

L 306/D 2700-3300 Kg.

ATE

B

22,0

809906

809906

L 206/D 2700-3300 Kg.

ATE

B

22,0

809906

809906

BM 611

407/409/410

1981-

ATE

F

22,0

809907

809907

MCC

Smart

Alle/All

7/98-10/99

B

17,4

803317

803318

Alle/All

11/99-

B

22,0

803319

803320



F/B

Ø

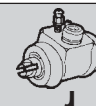
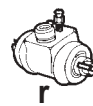

MITSUBISHI

Carisma

Alle/All

6/95-9/98

O.E

B

19,0

803019

803019

Alle/All

10/98-

O.E

B

19,5

803020

803020

Colt (C1_A)

Alle/All

12/78-4/88

O.E

B

19,0

803004

803004

Colt (C5_A)

Alle/All

4/88-5/90

O.E

B

19,0

803004

803004

Alle/All

6/90-5/92

O.E

B

19,0

803017

803017

Colt (CA_A)

Alle/All

4/92-4/96

O.E

B

19,0

803017

803017

Colt (CJ_A)

Alle/All, (-ABS)

11/95-

O.E

B

19,0

803017

803017

Alle/All, ABS

11/95-

O.E

B

17,4

803018

803018

Cordia (A21_A)

Alle/All

10/82-12/86

O.E

B

17,4

803011

803011

Galant (E1A_)

1.6/1.8

6/84-12/87

O.E

B

17,4

803011

803011

Galant (E3A_)

1.8

11/87-6/89

O.E

B

17,4

803011

803011

1.8

7/89-10/92

O.E

B

17,4

803018

803018

L200 (K_4T)

2.5 D/2.5 TD 4WD/2.6 4WD

12/87-8/96

O.E

B

22,2

803012

803013

2.5 D

11/86-8/96

O.E

B

23,8

803014

803015

L200 (K6_T)

Alle/All

6/96-

O.E

B

23,8

803014

803015

L300

1.6 (P02V,P12V)

11/90-

O.E

B

22,2

803012

803013

Alle/All -1.6 (P02V,P12V)

9/81-

O.E

B

20,6

803002

803003

Lancer

Alle/All

11/83-5/90

O.E

B

19,0

803004

803004

Alle/All

6/90-95

O.E

B

19,0

803017

803017

1.5/1.6 16V, (-ABS)

12/95-

O.E

B

19,0

803017

803017

1.5/1.6 16V, ABS

12/95-

O.E

B

17,4

803018

803018

1.6 16V 4WD

6/92-

O.E

B

17,4

803011

803011

Lancer Wagon

Alle/All -4x4

9/85-6/92

O.E

B

20,6

803016

803016



F/B

Ø

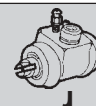
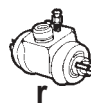

MITSUBISHI

Pajero I

2.5 TD/3.0 V6

5/86-12/91

O.E

B

22,2

803012

803013

2.3 TD/2.6

12/82-11/90

O.E

B

20,6

803002

803003

Pajero II

2.4, 4 WD

4/91-4/00

O.E

B

23,8

803014

803015

Space Gear

Alle/All

5/95-

O.E

B

22,2

803012

803013

Space Runner

1800i 16V (N11W)

10/91-8/99

O.E

B

19,0

803017

803017

1800i 16V (N21W)/2.0 TD GLX (N18W)

10/91-8/99

O.E

B

19,0

803004

803004

Space Star

Alle/All

6/98-9/98

O.E

B

19,0

803019

803019

Alle/All

10/98-5/00

O.E

B

19,0

803004

803004

Space Wagon

Alle/All - 4X4 (D0_V/W)

1/84-4/91

O.E

B

20,6

803016

803016

1.8/1.8TD/2.0TD -4X4

10/91-10/98

O.E

B

19,0

803004

803004

Tredia

Alle/All

9/82-10/87

O.E

B

17,4

803011

803011



F/B

Ø

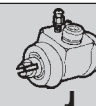
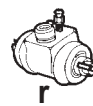

NISSAN

1000 B10

Alle/All

66-70

O.E

B

20,0

802209 U

802209 U

1200 B110

Alle/All

70-73

O.E

B

20,0

802209 U

802209 U

100 NX (B13)

1.6

3/90-10/94

TOK

B

15,8

802241

802241

Almera I (N15)

Alle/All

9/95-7/00

TOK

B

15,8

802241

802241

Bluebird (T12/T72)

Alle/All

12/85-6/87

O.E

B

20,6

802217

802217

872226 U

Alle/All

7/87-12/90

O.E

B

22,2

802238

802238

Bluebird (U11/WU11)

Alle/All

10/83-9/87

O.E

B

20,6

802217

802217

872226 U

Alle/All

10/87-5/90

O.E

B

22,2

802238

802238

Cherry (E10)

1.0

9/70-9/78

O.E

B

17,4

802201

802202

Cherry (N12)

Alle/All

5/82-12/86

O.E

B

17,4

802222

802222

Datsun 100A

Alle/All

12/74-8/80

O.E

B

17,4

802201

802202

Datsun (140/160/180)

Alle/All

1/73-6/83

O.E

B

20,6

802217

802217

872226 U

Datsun (120)

Alle/All

5/73-11/77

O.E

B

20,0

802211 U

802211 U

Laurel

Alle/All

7/81-12/89

O.E

B

22,2

802238

802238

Micra (K10)

Alle/All

12/82-7/92

O.E

B

15,9

802225

802225

Micra (K11)

Alle/All

8/92-2/03

O.E

B

17,4

802244

802244

Patrol (K160/W160)

Alle/All

11/79-8/88

O.E

B

22,2

802226

802226

Patrol (K260/W260)

Alle/All

5/86-9/89

O.E

B

22,2

802226

802226

Alle/All

10/89-11/95

O.E

B

25,4

802245

802245



F/B

Ø

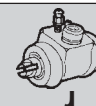
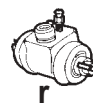

NISSAN

Patrol (Y60)

Alle/All

9/88-6/97

O.E

B

25,4

802245

802245

Patrol (Y61)

Alle/All -3.0DTi

6/97-

O.E

B

25,4

802245

802245

Pick up (720)

L18/SD23, 2 WD

7/80-11/81

O.E

B

17,0

802231

802231

Z22/SD25, 4 WD

12/81-3/83

O.E

B

14,3

802233 U

802233 U

1.8/2.2D/2.3D, 2 WD

1/82-3/86

O.E

B

17,4

802229

802229

2.2 & 2.5D 4WD, 4 WD

4/83-3/86

O.E

B

16,0

802232

802232

Pick up (D21)

2.0, 2 WD

9/85-8/91

O.E

B

17,4

802234

802234

2.5D 4WD, 4 WD

9/85-7/89

O.E

B

15,0

802236

802236

2.5D 4WD, 4 WD

8/89-

O.E

B

20,6

802246

802246

2.3D, 2 WD

9/85-8/88

O.E

B

19,0

802235

802235

Alle/All (4 cyl.)

9/85-2/98

O.E

B

22,2

802250

802250

Prairie (M10)

Alle/All

7/83-12/87

O.E

B

17,4

802224 U

802224 U

Prairie (NM10)

2.0 4X4

6/86-8/87

O.E

B

19,0

802237

802237

2.0 4X4

9/87-9/88

O.E

B

22,2

802238

802238

Prairie (M11)

2.0i

10/88-4/92

O.E

B

20,6

802217

802217

2.0i 4X4

10/88-12/92

O.E

B

22,2

802238

802238

2.4i 4X4

4/92-7/94

O.E

B

19,0

802237

802237

2.4i

4/92-7/94

O.E

B

17,4

802242

802242

Primera (P10)

1.6/2.0D

10/90-1/96

O.E

B

20,6

802239

802240

Primera Wagon (W10)

1.6/2.0D

7/90-3/98

O.E

B

20,6

802217

802217

872226 U

Primera (P11)

1.6 16V/2.0 TD

9/96-

O.E

B

802249

802249

Serena (C23M)

Alle/All

11/92-

O.E

B

23,8

802248

802248



F/B

Ø

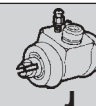
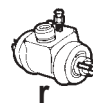

NISSAN

Silvia (S110)

1.8 Turbo

1/79-5/83

O.E

B

20,6

802217

802217

Silvia (S12)

2.0 GP

4/84-9/88

O.E

B

22,2

802238

802238

Stanza (T11)

Alle/All

8/81-12/85

O.E

B

17,4

802224 U

802224 U

Sunny (140Y,150Y)

Alle/All

1/70-2/82

O.E

B

20,6

802217

802217

Sunny (B11)

Alle/All

3/82-9/87

O.E

B

17,4

802222

802222

Sunny (N13,B12)

Alle/All

6/86-10/91

O.E

B

17,4

802222

802222

Sunny (N14)

1.4/1.6/2.0 D

10/90-5/95

TOK

B

15,8

802241

802241

Sunny Wagon (Y10)

Alle/All

11/90-

O.E

B

17,4

802242

802242

Terrano II (R20)

Alle/All, (3 Dørs/Door/Türig)

1/90-

O.E

B

22,2

802247

802247

Alle/All, (5 Dørs/Door/Türig)

1/90-

O.E

B

23,8

802248

802248

Urvan (E23)

2.0/2.3 Diesel

4/82-85

O.E

B

17,4

802229

802229

2.0/2.3 Diesel

85-87

O.E

B

19,0

802235

802235

Urvan (E24)

2.0/2.4 & 2.3 D/2.5 D

1/87-

O.E

B

20,6

802243

802243

Vanette (C22)

2.4i (SLC22)

10/86-12/95

O.E

B

20,6

802217

802217

Vanette Bus (C22)

Alle/All

10/86-12/95

O.E

B

17,4

802242

802242

Vanette Bus (KC120)

1.5

1/83-12/87

O.E

B

19,0

802237

802237

Vanette Kasse (C22)

2.0 D

7/91-1/95

O.E

B

19,0

802237

802237

Vanette Cargo

Alle/All

1/95-

O.E

B

23,8

802248

802248



F/B

Ø

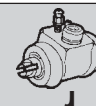
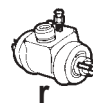

OPEL

Arena

Alle/All (-ABS)

3/98-8/01

BEN

B

23,8

803919

803919

Alle/All (ABS)

3/98-8/01

LUC

B

25,4

803644

803644

Ascona A

1.6N CH. ->2453080,->9483907

10/70-

ATE

B

15,8

803606

803606

1.6N CH. 2453081->, 9483908->

-9/74

ATE

B

15,8

803610

803610

1.6S/1.9 CH. ->2761436, 9662824

70-

ATE

B

15,8

803606

803606

1.6S/1.9 CH. 2761437->, 9662825->

-9/74

ATE

B

19,0

803611

803611

Ascona B

1.2/1.3N/1.6N

10/74-7/81

ATE

B

15,8

803610

803610

1.3S/1.6N Aut./1.6S/1.9/2.0/2.0D

10/74-7/81

ATE

B

19,0

803611

803611

1.2/1.3N/1.6N HD + (S)

10/74-7/81

ATE

B

19,0

809930

809930

Ascona C

1.3/1.6/1.8/2.0/Diesel

8/81-85

DEL

B

17,4

803623

803623

CH. ->G6000000,->G1001771

1.3/1.6/1.8/2.0/Diesel

86-8/88

ATE

B

17,4

803628

803628

CH. G6000001->/G1001772->

2.0i 95kW

10/87-8/88

ATE

B

19,0

803629

803629

Astra F

Alle/All CH. ->R2500000

10/91-

ATE

B

17,4

803628

803628

Alle/All CH. R2500001->

10/91-

ATE

B

19,0

803629

803629

Alle/All CH. R2500001-> (Aluminium) (18)

10/91-

ATE

B

19,0

803640

803640

Astra F Caravan/Kombi

Alle/All

10/91-

ATE

B

19,0

803629

803629

Alle/All, (Aluminium) (18)

10/91-

ATE

B

19,0

803640

803640

Astra G

1.2/1.4 16V/1.6/1.7 TD Sedan & Caravan

2/98-

ATE

B

19,0

803629

803629

1.2/1.6/1.7 TD Sedan & Caravan,

2/98-

ATE

B

19,0

803640

803640

(Aluminium) (18)

Campo

Alle/All

8/91-8/96

O.E

B

25,4

801433

801433

Combo (71_)

Alle/All

7/94-10/01

DEL

B

19,0

803630

803630

Combo (Kasse/Wagon)

Alle/All, (Aluminium) (18)

10/01-

ATE

B

19,0

803640

803640

Combo Tour

Alle/All, (Aluminium) (18)

10/01-

ATE

B

19,0

803640

803640

Commodore A

Alle/All

8/67-1/72

ATE

B

17,4

803625

803625



F/B

Ø

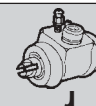
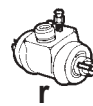

OPEL

Commodore B

Alle/All

1/72-7/78

ATE

B

22,2

803616

803616

Commodore C

Alle/All

8/78-12/82

ATE

B

22,2

803616

803616

Corsa A

1.0 CH. ->G4000000

9/82-7/86

DEL

B

14,3

803622

803622

1.0 CH. G40000001->

8/86-

ATE

B

14,3

803627

803627

1.0/1.2/1.3 (+ HD) CH. ->G4000000

9/82-7/86

DEL

B

17,4

803623

803623

1.0/1.2/1.3 (+ HD) CH. G40000001->

8/86-93

ATE

B

17,4

803628

803628

1.4/1.5 D/1.5 TD/1.6/1.6GSI

9/87-93

ATE

B

17,4

803628

803628

Corsa B

Alle/All

3/93-9/00

ATE

B

19,0

803629

803629

Alle/All, (Aluminium) (18)

3/93-9/00

ATE

B

19,0

803640

803640

Corsa C

Alle/All

9/00-

ATE

B

19,0

803629

803629

Alle/All, (Aluminium) (18)

9/00-

ATE

B

19,0

803640

803640

Frontera A

Alle/All CH. ->SV720102

3/92-10/98

O.E

B

25,4

801433

803919

Kadett A

Alle/All

62-65

ATE

B

15,8

803603

803603

Kadett B

1.0/1.1/1.2

65-73

ATE

F

23,8

803604 U

803605

1.0/1.1/1.2

65-73

ATE

B

15,8

803603

803603

1.5/1.7/1.9

67-71

ATE

B

15,8

803606

803606

Kadett C

1.0/1.2

8/73-7/79

ATE

F

23,8

803604 U

803605

1.0/1.2

8/73-7/79

ATE

B

15,8

803603

803603

GT/E/1.6/1.9/2.0

9/75-7/79

ATE

B

19,0

809930

809930

Kadett D

1.0/1.2/1.3N

8/79-7/84

DEL

B

14,3

803620

803620

1.0/1.2/1.3 Kombi CH. ->2518194

8/79-

DEL

B

19,0

803609 U

803609 U

1.0/1.2/1.3 Kombi CH. 2518195->

-7/84

ATE

B

19,0

803619

803619

1.2 HD/1.3 Aut.

8/79-7/84

ATE

B

19,0

803611

803611

1.3N/S

8/79-7/84

DEL

B

17,4

803623

803623

1.6/1.8/1.6 D

82-7/84

DEL

B

17,4

803623

803623



F/B

Ø

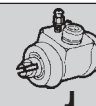
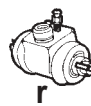

OPEL

Rekord B/C

Alle/All 65-71 ATE B 15,8 803606 803606

Rekord D

1.7 72-77 ATE B 15,8 803606 803606

1.7 (S) 72-77 ATE B 19,0 803611 803611

1.9 72-77 ATE B 19,0 803611 803611

2.0 75-77 ATE B 19,0 803611 803611

2.1 Diesel 72-9/73 ATE B 15,8 803606 803606

2.1 Diesel 10/73-77 ATE B 19,0 803611 803611

Rekord E

1.7/1.9 77-9/82 ATE B 15,8 803606 803606

1.7/1.9 HD CH. ->F1000188 9/77- ATE B 19,0 803611 803611

1.7/1.9 CH. F1000189-> -86 DEL B 19,0 803630 803630

1.8 CH. F1000189-> -86 DEL B 19,0 803630 803630

1.8N 10/82-86 ATE B 15,8 803606 803606

1.8N HD 10/82-86 ATE B 19,0 803611 803611

2.0 CH. ->F1000188 9/77- ATE B 19,0 803611 803611

2.0 CH. F1000189-> -86 DEL B 19,0 803630 803630

2.0E (S) 9/77-8/86 ATE B 22,2 803616 803616

2.2E CH. ->F1000128 9/85- DEL B 19,0 803630 803630

2.2E CH. F1000129-> -8/86 ATE B 22,2 803632 U 803632 U

Alle/All, ABS 84-86 ATE B 22,2 803632 U 803632 U

Diesel CH. ->F1000188 77-9/82 ATE B 19,0 803611 803611

Diesel CH. F1000189-> -86 DEL B 19,0 803630 803630

Rekord E Kombi

Alle/All CH. ->F1000188 77- ATE B 22,2 803616 803616

Alle/All CH. F1000189-> -86 ATE B 22,2 803632 U 803632 U

Tigra

1.4 16V & 1.6 16V 7/94- ATE B 19,0 803629 803629

1.4 16V & 1.6 16V, (Aluminium) (18) 7/94- ATE B 19,0 803640 803640

Vectra A

1.4/1.6/1.8/1.7 Diesel 9/88-8/95 ATE B 19,0 803629 803629

1.4/1.6/1.8/1.7 Diesel, (Aluminium) (18) 9/88-8/95 ATE B 19,0 803640 803640



F/B

Ø

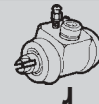
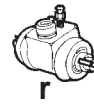

OPEL

Vectra B

1.6
1.6, (Aluminium) (18)

9/95-

ATE

B

19,0

803629

803629

9/95-

ATE

B

19,0

803640

803640

Zafira

Alle/All

4/99-

B

20,6

803643

803643



F/B

Ø

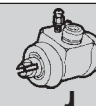
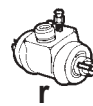

PEUGEOT

104

GL	7/75-9/76	LUC	B	22,2	809932	809933
GL/GR/S/SR	9/76-	BEN	B	22,0	809911	809911
GL/GR/S/SR	9/76-	LUC	B	22,2	809935	809935
GL6/SL CH. 7236001-> CH. ->7241000 (5)		BEN	B	20,6	809910	809910
GL6/SL CH. 7236001-> CH. ->7241000		LUC	B	20,6	801918	801918
ZL	7/75-9/76	LUC	B	22,2	809932	809933
ZA/ZL/ZS	9/76-	BEN	B	22,0	809911	809911
ZA/ZL/ZS	9/76-	LUC	B	22,2	809935	809935

106 I

Alle/All (165 mm. Tromle/Drum/Trommel), (-ABS)	9/91-4/96	BEN	B	19,0	803747	803748
Alle/All (180 mm. Tromle/Drum/Trommel), (-ABS)	9/91-4/96	BEN	B	19,0	809957	809958
Alle/All, ABS	9/91-4/96	BEN	B	19,0	803749	803749

106 II

1.0 (165 mm. Tromle/Drum/Trommel), (3 Bolthuller/Rim holes/Loch Felgen),	3/96-	BEN	B	19,0	803747	803748
1.0 (180 mm. Tromle/Drum/Trommel), (-ABS)	3/96-	BEN	B	19,0	809957	809958
1.0, ABS	3/96-	LUC	B	20,6	801930	801930
1.1/1.4/1.6, (-ABS)	3/96-	BEN	B	19,0	809957	809958
1.1/1.4/1.6, ABS	3/96-	LUC	B	20,6	801930	801930
1.5 Diesel, ABS CH. ->08056	3/96-	LUC	B	20,6	801930	801930
1.5 Diesel, ABS CH. 08057->	3/96-	LUC	B	20,6	803755	803755
1.5 Diesel (165 mm. Tromle/Drum/Trommel), (3 Bolthuller/Rim holes/Loch Felgen),	3/96-	BEN	B	19,0	803747	803748
1.5 Diesel (180 mm. Tromle/Drum/Trommel), (-ABS)	3/96-	BEN	B	19,0	809957	809958

205 I & II

Alle/All -GTI	2/83-9/98	BEN	B	19,0	803731	803732
Alle/All -GTI	2/83-9/98	LUC	B	19,0	803739	803740
Alle/All GTI & Rallye & Turbo Diesel	12/84-9/98	LUC	B	19,0	803739	803740
Alle/All GTI & Rallye & Turbo Diesel	12/84-9/98	LUC	B	19,0	803746	803746

205 Kasse

1.7 Diesel	3/94-	BEN	B	19,0	803731	803732
1.7 Diesel	3/94-	LUC	B	19,0	803739	803740

206

1.1/1.4/1.6/1.9 D/2.0 HDi	9/98-	LUC	B	20,6	803755	803755
---------------------------	-------	-----	---	------	---------------	---------------

305 II

Alle/All	10/82-7/90	BEN	B	20,6	809931	809931
Alle/All	10/82-7/90	LUC	B	20,6	809940	809940



F/B

Ø

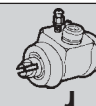
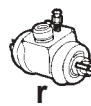

PEUGEOT

306

1.1/1.4/1.6SR/1.8/1.7D/1.9D&TD	5/93-	BEN	B	20,6	801927	801927
1.1/1.4/1.6SR/1.8/1.7D/1.9D&TD, (-ABS)	5/93-	BEN	B	20,6	803929	803930
1.1/1.4/1.6SR/1.8/1.7D/1.9D&TD, (-ABS)	5/93-	LUC	B	20,6	809949	809950
1.4/1.6SR/1.8/1.7D/1.9D&TD, ABS	5/93-7/95	LUC	B	20,6	809934	809934
1.4/1.6SR/1.8/1.7D/1.9D&TD, ABS	5/95-	LUC	B	20,6	801930	801930
1.6, (-ABS) (6)	10/00-	LUC	B	20,6	809949	809950
1.6, ABS	10/00-	LUC	B	20,6	803755	803755

306 Break

Alle/All, (-ABS)	2/97-	BEN	B	20,6	801927	801927
Alle/All, ABS	2/97-	BEN	B	22,0	801932	801932

309 I

1.1/1.3	10/85-7/89	BEN	B	17,4	809945	809946
1.6/1.9	9/85-6/89	BEN	B	22,2	809942	809941
1.6/1.9	10/85-12/89	LUC	B	22,2	809932	809933

309 II

Alle/All (-GTi)	7/89-12/93	BEN	B	20,6	803741	803742
Alle/All (-GTi) (6)	7/89-12/93	LUC	B	20,6	809947	809948
Alle/All, ABS	7/89-12/93	LUC	B	20,6	809934	809934

405 I & II

Alle/All	1/87-10/95	BEN	B	20,6	803743	803744
Alle/All, (-ABS)	1/87-10/95	LUC	B	20,6	803754	803754
Alle/All, ABS	1/87-10/95	LUC	B	20,6	809940	809940

405 I Break

Alle/All, ABS	10/88-8/92	LUC	B	20,6	809940	809940
---------------	------------	-----	---	------	---------------	---------------

405 II Break

Alle/All, (-ABS)	8/92-10/96	LUC	B	20,6	809940	809940
Alle/All, ABS	8/92-10/96	LUC	B	20,6	803754	803754

406

1.6/1.8/1.9 D & 1.9 TD Berline, ABS	11/95-	BEN	B	20,6	803750	803751
1.6/1.8/1.9 D & 1.9 TD Berline, (-ABS)	11/95-	BEN	B	20,6	803752	803753
1.8 & 1.9 TD Break, ABS	10/96-	BEN	B	20,6	803750	803751
1.8 & 1.9 TD Break, (-ABS)	10/96-	BEN	B	20,6	803752	803753

504

Alle/All	7/68-12/89	LUC	B	22,2	809932	809933
----------	------------	-----	---	------	---------------	---------------

Break/Cabriolet/Coupe/Pick

Alle/All	4/71-12/89	LUC	B	22,2	803745	803745
----------	------------	-----	---	------	---------------	---------------



F/B

Ø

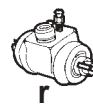

R

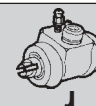

J



PEUGEOT

505

Alle/All CH. 1214235->

8/79-12/93

BEN

B

20,6

809929

809929

Alle/All CH. ->1214234

8/79-12/93

LUC

B

22,2

809932

809933

Alle/All CH. 1214235->

8/79-12/93

LUC

B

20,6

809934

809934

505 Break

Alle/All

4/82-12/93

LUC

B

22,2

803745

803745

806

1.8/1.9 TD/2.0i

6/94-8/02

BEN

B

19,0

801926

801926

Boxer 10/14

Alle/All

3/94-4/02

LUC

B

25,4

802340

802340

Boxer 14

Alle/All

3/94-4/02

LUC

B

27,0

802341

802341

Boxer 18

Alle/All

3/94-4/02

LUC

B

28,6

802342

802342

Expert

Alle/All

2/96-

BEN

B

19,0

801926

801926

J 5

Alle/All

9/81-10/82

LUC

B

22,2

809944 U

809944 U

Alle/All

11/82-

LUC

B

25,4

809936

809936

Alle/All 1800 Kg.

9/87-

LUC

B

27,4

809955

809955

Alle/All 800 Kg.

2/89-

LUC

B

22,2

801928

801928

Partner

Alle/All

6/96-

LUC

B

22,2

801929

801929



F/B

Ø

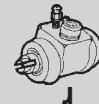
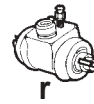

PORSCHE

924

Alle/All

8/75-8/85

B

19,0

805601

805601



F/B

Ø

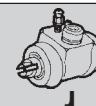
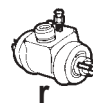

RENAULT

			F/B	Ø	R	J
4						
0.8/1.1	10/62-6/90	BEN	F	23,8	803901	803902
0.8 CH. ->21494	10/62-7/66	BEN	B	19,0	803903	803903
0.8 CH. 21495->	10/62-6/90	BEN	B	21,0	803906	803906
0.8/1.0/1.1	7/82-6/90	BEN	B	22,2	803904	803904
0.8/1.0/1.1	7/82-6/90	LUC	B	22,2	803905	803905
5						
0.8	10/72-12/84	BEN	F	23,8	803901	803902
0.8 CH. ->116673	7/71-	BEN	B	19,0	803903	803903
0.8/1.0/1.1/1.3/1.4	10/72-12/85	BEN	B	22,2	803904	803904
0.8/1.0/1.1/1.3/1.4	10/72-12/85	LUC	B	22,2	803905	803905
5 Super						
Alle/All	10/84-5/87	BEN	B	22,2	809942	809941
Alle/All	6/87-10/90	BEN	B	20,6	803940	803941
Alle/All	10/84-10/90	LUC	B	22,2	809932	809933
6						
0.8	10/69-4/80	BEN	B	23,8	803901	803902
1.1	8/70-4/87	BEN	B	22,2	803904	803904
1.1	8/70-4/87	LUC	B	22,2	803905	803905
9						
Alle/All	81-9/86	BEN	B	17,4	809945	809946
Alle/All	10/86-	BEN	B	22,2	809942	809941
Alle/All	81-	LUC	B	22,2	809932	809933
11						
Alle/All	83-9/86	BEN	B	17,4	809945	809946
Alle/All	10/86-	BEN	B	22,2	809942	809941
Alle/All	83-	LUC	B	22,2	809932	809933
12						
Berline CH. 296081->	10/69-8/80	LUC	B	22,2	803922	803922
Break	8/70-8/80	BEN	B	22,0	803911 U	803911 U
14						
Alle/All	5/76-12/83	BEN	B	22,2	809942	809941
Alle/All	5/76-12/83	LUC	B	22,2	809932	809933
15						
1.6	3/72-10/80	BEN	B	22,0	803911 U	803911 U
16						
Alle/All	9/65-8/80	BEN	B	22,0	803911 U	803911 U
17						
Alle/All	3/72-10/80	BEN	B	22,0	803911 U	803911 U



F/B

Ø

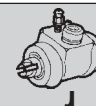
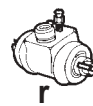

RENAULT

18 Berline

L,TL,GTL R1340/1349	4/78-6/83	BEN	B	22,2	809941	809942
L,TL,GTL R1340	7/83-	BEN	B	22,2	809941	
L,TL,GTL R1340/1349	4/78-	LUC	B	22,2	809933	809932
TS,GTS R1341/1342	4/78-6/83	BEN	B	22,2	809941	809942
TS,GTS R1341/1342	7/83-	BEN	B	22,2	809941	
TS,GTS R1341/1342	4/78-	LUC	B	22,2	809933	809932
TX,GTX R1343	10/81-	BEN	B	22,0	809943	809943
TD,GTDR1344	10/80-	BEN	B	22,2	809941	809942
TD,GTDR1344	10/81-	LUC	B	22,2	809933	809932
Turbo R1345	10/80-7/82	BEN	B	22,0	809943	809943
Turbo Diesel R1346	7/83-	BEN	B	22,0	809943	809943

18 Break

TL R1350 CH. ->114800	2/79-	BEN	B	22,0	809943	809943
TL R1350 CH. 114801->		BEN	B	22,0	809943	803917
GTL R1351 CH. ->107200	2/79-	BEN	B	22,0	809943	809943
GTL R1351 CH. 107201->		BEN	B	22,0	809943	803917
GTL 4x4 R1351	83-	BEN	B	22,0	809943	803917
GTS R1352 CH. ->5480	10/81-	BEN	B	22,0	809943	809943
GTS R1352 CH. 5481->		BEN	B	22,0	809943	803917
TS,GTS R1352 CH. ->5400	10/81-	BEN	B	22,0	809943	809943
TS,GTS R1352 CH. 5401->		BEN	B	22,0	809943	803917
GTX R1353 CH. ->5000	10/81-	BEN	B	22,0	809943	809943
GTX R1353 CH. 5001->		BEN	B	22,0	809943	803917
GTX 4x4 R1353	83-	BEN	B	22,0	809943	803917
GTDR1354	10/80-	BEN	B	22,0	809943	809943
GTDR1354	83-	BEN	B	22,0	809943	809943
TL R1359 (S,CH) CH. ->200	2/79-	BEN	B	22,0	809943	809943
TL R1359 (S,CH) CH. 201->		BEN	B	22,0	809943	803917
Société R2350 CH. ->3400	10/81-	BEN	B	22,0	809943	809943
Société R2350 CH. 3401->		BEN	B	22,0	809943	803917
Société Diesel R2354	10/81-	BEN	B	22,0	809943	809943
Turbo R135B	10/83-	BEN	B	22,0	809943	809943



F/B

Ø

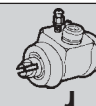
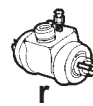

RENAULT

18 Break

Turbo Diesel R1356

10/83-

BEN

B

22,0

809943

809943

19 I

Alle/All

9/88-3/91

BEN

B

20,6

803927

803928

Alle/All (6)

4/91-

BEN

B

20,6

803929

803930

Alle/All

4/91-

LUC

B

20,6

803948

803949

19 II

Alle/All

4/92-6/96

BEN

B

19,0

803955

803956

Alle/All (6)

4/92-6/96

BEN

B

20,6

803929

803930

Alle/All

4/92-6/96

LUC

B

20,6

803948

803949

20

Alle/All

10/75-12/83

BEN

B

22,0

803933

803934

Alle/All

10/75-12/83

LUC

B

23,8

803935

803935 U

21

Alle/All

7/86-5/87

BEN

B

22,2

809942

809941

Alle/All

6/87-3/91

BEN

B

22,0

803944

803944 U

Alle/All

4/91-

BEN

B

22,0

803946

803947

25

Alle/All, (-ABS)

4/84-12/93

BEN

B

22,0

803933

803934

Alle/All, (-ABS)

4/84-12/93

LUC

B

23,8

803935

803935 U

30

2.1 Turbo Diesel

2/82-3/86

BEN

B

22,0

803933

803934

2.1 Turbo Diesel

2/82-3/86

LUC

B

23,8

803935

803935 U

Clio I

Alle/All (- 1.7 16S)

6/90-3/91

BEN

B

20,6

803940

803941

Alle/All (- 1.7 16S)

4/91-9/98

BEN

B

20,6

803925

803926

Alle/All

6/90-3/91

LUC

B

20,6

803951

803952

Alle/All

4/91-9/98

LUC

B

20,6

803953

803954

Clio II

1.2/1.4/1.5 Dci/1.6/1.9 D/1.9 Dti, (-ABS)

9/98-

BOS

B

19,0

803967

803967

1.2/1.4/1.5 Dci/1.6/1.9 D/1.9 Dti, ABS

9/98-

BOS

B

17,5

803966

803966

1.2/1.4/1.5 Dci/1.6/1.9 D/1.9 Dti, ABS

9/98-

LUC

B

17,8

803960

803960

Espace I

Alle/All

7/84-12/92

BEN

B

22,0

809943

809943

Espace II

Alle/All -2.1 TD

1/91-4/92

BEN

B

22,0

809943

809943

2.1 TD

11/94-10/96

LUC

B

22,2

803745

803745

Espace III

1.9 dti/2.0/2.2 12V

11/96-

LUC

B

22,2

803745

803745



F/B

Ø

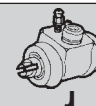
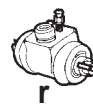

RENAULT

Express (Rapid)

GTC F 40H CH. ->E00000235	6/87-9/91	LUC	B	22,2	809932	809933
GTC F 40H CH. ->F00001604	6/87-9/91	LUC	B	22,2	809932	809933
GTC F 40H	6/87-9/91	BEN	B	22,2	809942	809941

C,TC F400 CH. ->J0002617	10/85-4/95	LUC	B	22,2	809932	809933
C,TC F400	10/85-4/95	BEN	B	22,2	809942	809941

TL F 401 CH. ->J00073241	10/85-4/95	LUC	B	22,2	809932	809933
TL F 401 CH. ->E00008743	10/85-4/95	LUC	B	22,2	809932	809933

TL F 401	10/85-4/95	BEN	B	22,2	809942	809941
----------	------------	-----	---	------	---------------	---------------

Diesel F 404	10/85-6/86	LUC	B	22,2	809932	809933
--------------	------------	-----	---	------	---------------	---------------

1.4 Diesel & 1.6 Diesel	86-12/88	BEN	B	22,0		
1.4 Diesel & 1.6 Diesel	1/89-8/98	BEN	B	20,6	803931	803932

Fuego

TL R1360 CH. ->59000	2/80-10/85	BEN	B	22,2	809941	809942
TL R1360 CH. 59001->	2/80-84	BEN	B	22,2	809941	

GTL R1361 CH. ->6100	82-10/85	BEN	B	22,2	809941	809942
----------------------	----------	-----	---	------	---------------	---------------

TS,GTS R1362 CH. ->59300	2/80-10/85	BEN	B	22,0	809943	809943
TS,GTS R1362 CH. 59301->	2/80-10/85	BEN	B	22,0	809943	803917

TX,GTX R1363	10/80-10/85	BEN	B	22,0	809943	809943
--------------	-------------	-----	---	------	---------------	---------------

Turbo Diesel R1366	7/83-10/85	BEN	B	22,0	809943	809943
--------------------	------------	-----	---	------	---------------	---------------

GTX Turbo Injection R136B	84-10/85	BEN	B	22,0	809943	809943
---------------------------	----------	-----	---	------	---------------	---------------

Kangoo

Alle/All (16)	3/98-	O.E	B		803963	803963
Alle/All	3/98-	O.E	B		803964	803964

Laguna

1.6 16V (B568, B561)	11/97-3/01	LUC	B	20,6	801930	801930
----------------------	------------	-----	---	------	---------------	---------------

1.8, B56A/B	1/94-	LUC	B	19,0	803959	803959
-------------	-------	-----	---	------	---------------	---------------

1.9 dti (B56J)	10/97-3/01	LUC	B	20,6	801930	801930
----------------	------------	-----	---	------	---------------	---------------

2.0	3/99-3/01	LUC	B	20,6	801930	801930
-----	-----------	-----	---	------	---------------	---------------

2.0 B56C/H	1/94-	LUC	B	19,0	803959	803959
------------	-------	-----	---	------	---------------	---------------

2.2 B56F	7/94-	LUC	B	19,0	803959	803959
----------	-------	-----	---	------	---------------	---------------

1.8/2.2 & 2.2 D Grandtour	9/95-3/01	LUC	B	20,6	801930	801930
1.8/2.2 & 2.2 D Grandtour	9/95-3/01	LUC	B	22,2	803968	803968



F/B

Ø

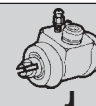
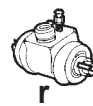

RENAULT

Nevada

Alle/All

7/86-6/95

LUC

B

22,0

803961

803962

Master I

Alle/All

8/80-7/98

LUC

B

25,4

809936

809936

Master II

Alle/All

7/98-

BOS

B

23,8

803641

803642

Megane

Alle/All

11/95-

BEN

B

17,4

803950

803950

1.4 16V/1.6 16V, ABS

1/99-

O.E

B

19,0

803965

803965

Megane Grandtour

1.9 Diesel

4/99-

LUC

B

20,6

801930

801930

Megane Scenic

Alle/All

10/96-

LUC

B

20,6

801930

801930

Safrane I

2.0 & 2.2 & 2.1 TD, (-ABS)

5/92-7/96

LUC

B

22,2

803745

803745

Scenic

Alle/All

9/99-

LUC

B

20,6

801930

801930

Trafic

Alle/All

3/80-

BEN

B

23,8

803919

803919

Alle/All

3/80-

LUC

B

22,0

803917

803917

Alle/All (ABS)

3/80-

LUC

B

25,4

803644

803644

Twingo

Alle/All, (-ABS)

3/93-

BEN

B

20,6

803957

803958

Alle/All, ABS

3/94-

BEN

B

801931

801931

1.2 16V (C06_), ABS

1/01-

LUC

B

17,8

803960

803960



F/B

Ø

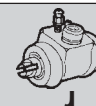
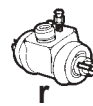

ROVER GROUP

Austin

1300	67-74	LCH	B	20,3	801205	801205	879905 U
2200	10/72-75	LUC	B	18,0	801220 U	801220 U	
2200 (3)	10/72-75	LUC	B		899901	899901	

Austin Allegro

Alle/All	73-84	LUC	B	14,3	801214	801214	
Alle/All (3)	73-84	LUC	B		899901	899901	

Austin Maestro

Alle/All	83-95	LUC	B	15,8	801226	801227	
----------	-------	-----	---	------	---------------	---------------	--

Austin Maxi

Alle/All	69-10/78	LUC	B	17,4	809919	809919	
Alle/All	11/78-81	LUC	B	14,3	801207	801207	

Austin Metro

Alle/All	10/80-4/90	LCH	B	17,4	801225	801225	
----------	------------	-----	---	------	---------------	---------------	--

Austin Mini MK I

850/1000 & Clubman	59-	LCH	B		891202	891202	
850/1000	59-64	LCH	B	19,0	809916	809916	
1000/1300/1300 Cabriolet	91-	LCH	B	19,0	809916	809916	

850/1000 & Clubman	67-84	LCH	F	24,0	801201	801202	
850/1000 & Clubman	67-77	LCH	B	19,0	809916	809916	
850/1000 & Clubman	8/78-	LCH	B	19,0	809916	809916	

1275 GT (10" Hjul/Wheels/Rad)	69-74	LCH	B	16,0	809917	809917	
1275 GT (12" Hjul/Wheels/Rad)	9/78-80	LCH	B	19,0	809916	809916	

850/1000	64-67	LCH	B	16,0	809917	809917	
850/1000 & Clubman Comm. CH. 21571A->	-7/78	LCH	B	14,0	801204	801204	

Mini Cooper (MK III)

Alle/All (14)	69-71	LCH	B	16,0	809917	809917	
---------------	-------	-----	---	------	---------------	---------------	--

Austin MK I

1100	63-67	LCH	B	19,0	809916	809916	
------	-------	-----	---	------	---------------	---------------	--

Austin MK I / II & III

1800	5/65-75	LUC	B	18,0	801220 U	801220 U	
1800 (3)	5/65-75	LUC	B		899901	899901	

Austin MK II & III

1100	67-74	LCH	B	20,3	801205	801205	879905 U
------	-------	-----	---	------	---------------	---------------	-----------------

Austin Montego

Alle/All	4/84-8/91	LUC	B	17,4	801228	801229	
----------	-----------	-----	---	------	---------------	---------------	--



F/B

Ø

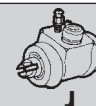
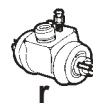

ROVER GROUP

Austin Princess

Alle/All 4/76-10/82 LCH B 14,3 801222 U 801222 U

Morris Marina

Marina 1.3 CH. ->172478 4/71-72 LUC F 19,0 809922 809923

Marina 1.3 4/71-80 LUC B 17,4 809919 809919

Marina 1.3 CH. 172479-> 72-80 LUC B 19,0 809915 809915

Marina 1.8 CH. 172479-> -8/82 LUC B 17,4 809919 809919

Morris Minor

1000 56-71 LCH F 24,0 801215 801216

1000 62-71 LCH B 19,0 801217 801217

Rover 100

Alle/All 3/90- LCH B 17,4 801225 801225

Rover 200

213 9/85-9/89 LCH B 19,0 804001 804002

214/216/218 & 220 10/89-10/95 LCH B 19,0 809953 809954

216 3/85-10/89 LCH B 17,4 809951 U

Rover 400 (XW)

Alle/All 4/90-4/95 LCH B 19,0 809953 809954

Rover Maestro

Alle/All 9/90-1/95 LCH B 17,4 801225 801225

Rover Mini MK I

Alle/All 1/91- LCH B 19,0 809916 809916

Acclaim

1.3 1/82-12/85 LCH B 19,0 804001 804002

Herald

Alle/All 1/61-12/71 LUC F 19,0 809915 809923

Alle/All 1/61-12/71 LUC B 19,0 809915 809915

Spitfire II & III

Alle/All 12/65-12/70 LUC B 19,0 809915 809915

MG RV8

Alle/All 93- LCH B 20,3 802531 802531 879905 U

MGB GT

Alle/All 62-67 LCH B 20,3 801205 801205 879905 U

Alle/All 67-82 LCH B

MGB Tourer & Roadster

Alle/All 62-82 LCH B 20,3 801205 801205 879905 U



F/B

Ø

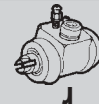
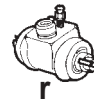

ROVER GROUP

Sherpa

Alle/All (- 185)

74-

LCH

B

22,2

809926

809927

SAAB

95/96

Alle/All

62-80

LCH

B

16,0

809917

809917

Alle/All

62-80

LCH

B

19,0

809916

809916



F/B

Ø

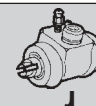
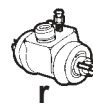

SEAT

Arosa

Alle/All, (-ABS)

5/97-

O.E

B

15,8

804709

804709

Alle/All, ABS (18)

5/97-

O.E

B

17,4

804739

804739

Cordoba

1.4/1.6/1.8/1.9 D/1.9 TD (18)

11/93-

ATE

B

17,4

804739

804739

Cordoba (6K1/C2)

1.7 Sdi & 1.9 Sdi

8/96-6/99

O.E

B

17,4

804706

804706

1.4 16V/1.6

6/99-10/02

LUC

B

19,0

804735

804735

Fura

Alle/All

1/82-12/86

BEN

B

19,0

802304

802304

Ibiza I

Alle/All

6/84-12/93

O.E

B

17,4

802331

802331

Ibiza II

Alle/All

3/93-8/99

O.E

B

17,4

804706

804706

Ibiza III (6K1)

1.0/1.4, (-ABS) (18)

8/99-2/02

O.E

B

17,4

804739

804739

1.4i 16V (44-55-74 kW)/1.6i (55kW),

8/99-2/02

ATE

B

17,4

804706

804706

1.4i 16V (44-55-74 kW)/1.6i (55kW),(-ABS) (17)

8/99-2/02

LUC

B

19,0

804735

804735

1.9 Sdi & Tdi, (Aluminium), (-ABS) (17+18)

8/99-2/02

B

19,0

804306

804306

1.9 Sdi & Tdi, (-ABS) (18)

8/99-2/02

ATE

B

17,4

804739

804739

Ibiza IV (6L1)

Alle/All (- Cupra), (-ABS) (17)

2/02-

LUC

B

19,0

804735

804735

Inca

1.4/1.6 & 1.9 D, (Aluminium) (18)

11/95-

FAG

B

20,6

804738

804738

Malaga

Alle/All

5/85-12/93

O.E

B

17,4

802331

802331

Marbella

Alle/All

8/86-10/98

O.E

B

19,0

802328

802328

Ronda

Alle/All

7/82-

O.E

B

17,4

802331

802331

Toledo I

1.6/1.8/1.9 D/1.9 TD

5/91-

O.E

B

17,4

804706

804706



F/B

Ø

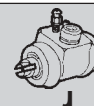
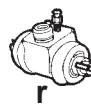

SKODA

105/120/130

Alle/All

8/76-10/91

O.E

B

19,0

804301

804301

Fabia

1.0/1.4/1.9Sdi, (Aluminium) (18)

12/99-

B

19,0

804306

804306

Favorit

Alle/All

89-12/92

O.E

B

19,0

804302

804302

Alle/All

1/93-

O.E

B

19,0

804303

804303

Felicia I-II

1.3/1.6

10/94-6/01

O.E

B

19,0

804303

804303

Felicia I-II Kombi

1.3/1.6/1.9D

8/95-6/01

LUC

B

22,2

804305

804305

Felicia I-II Pick-up

1.3/1.6/1.9D, ABS

96-

OE

B

19,0

804303

804303

1.3/1.6/1.9D, (-ABS)

96-

LUC

B

22,2

804305

804305

Felicia I-II

1.9D

96-6/01

LUC

B

20,6

804304

804304

Octavia

Alle/All

9/96-

B

20,6

804736

804736

Alle/All, Aut.

9/96-

LUC

B

19,0

804735

804735

Alle/All, (Aluminium) (18)

9/96-

FAG

B

20,6

804738

804738

Rapid

Alle/All

2/83-10/91

O.E

B

19,0

804302

804302

SUBARU

Justy II

1.3 4WD, (Aluminium) (18)

10/95-

O.E

B

17,4

805203

805204

Leone I

Alle/All

3/79-10/84

O.E

B

14,3

804401

804401

SUZUKI

Alto III

1.0

9/94-6/2002

B

17,4

805205

805205

Baleno

Alle/All, (18)

7/95-

B

17,4

805203

805204

Swift I

Alle/All, (18)

10/83-3/89

B

17,4

805201

805201



F/B

Ø

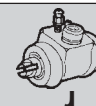
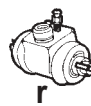

SUZUKI

Swift II

1.0/1.3, Hatchback (3&5 Dørs/Door/Türig) 3/89-
1.3, Hatchback (3&5 Dørs/Door/Türig) (18) 3/89-
1.3/1.6, Sedan (4 Dørs/Door/Türig) (18) 3/89-

Wagon R+

1.0/1.2 2/98-5/00

Vitara

Alle/All 12/94-3/99

X-90

Alle/All 9/95-

TALBOT

1307-1510

Alle/All 7/75-4/84 ATE B 20,6 801813 U 801813 U
Alle/All 7/75-4/84 BEN B 20,6 809931 809931
Alle/All 7/75-4/84 LUC B 20,6 809940 809940
Alle/All 7/75-4/84 BEN B 22,0 809943 809943

Avenger

Alle/All 2/70-7/81 LUC B 18,0 801820 U 801820 U

Horizon

Alle/All 2/78-6/86 ATE B 20,6 801813 U 801813 U
Alle/All 2/78-6/86 BEN B 20,6 809931 809931
Alle/All 2/78-6/86 LUC B 20,6 809940 809940

Rancho

1.4 1/77-7/84 LUC B 20,6 809940 809940

Samba

Alle/All 1/81-10/86 BEN B 22,0 809911 809911
Alle/All 1/81-10/86 LUC B 22,2 809935 809935

Simca Sunbeam

Alle/All 70-80 LUC B 18,0 801820 U 801820 U

Solara

Alle/All 2/80-7/86 ATE B 20,6 801813 U 801813 U
Alle/All 2/80-7/86 BEN B 22,0 809943 809943

Tagora

2.6/2.3 Diesel 10/80-7/83 LUC B 20,6 809934 809934
Alle/All 6/80-12/87 BEN B 20,6 809929 809929



F/B

Ø

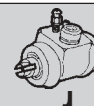
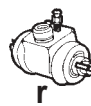

TOYOTA

Avensis

Alle/All

9/97-10/00

O.E

B

20,6

804553

804554

Camry

1.8 & 2.0

2/83-5/91

O.E

B

19,0

804529

804530

Carina

Alle/All

5/73-84

O.E

B

19,0

809938

809938

Carina II

AT151/ST150/CT150

6/84-1/86

O.E

B

19,0

804529

804530

AT151/ST150/CT150

1/86-87

O.E

B

17,4

804532

804531

874552 U

AT171/CT170/ST171

12/87-93

O.E

B

19,0

804529

804530

Carina E

Alle/All (-UK)

4/92-9/97

Hos

B

19,0

804545

804546

Alle/All (UK)

3/93-1/96

LUC

B

19,0

804549

804550

Alle/All (UK)

1/96-9/97

LUC

B

20,6

804551

804552

Celica (TA60,RA40,RA6_)

Alle/All

8/77-8/85

O.E

B

19,0

809938

809938

Celica (_T16_)&(_T18_)

Alle/All

8/85-8/90

O.E

B

19,0

804529

804530

Celica (AT180)

Alle/All

3/90-

O.E

B

19,0

804547

804548

Corolla (AL20)

1300 TE

84-2/85

O.E

B

17,4

804532

804531

874552 U

Corolla (KE20)

Alle/All

4/70-5/78

O.E

B

20,6

804507

804507

Corolla (KE30)

Alle/All

8/74-2/80

O.E

B

19,0

809938

809938

Corolla (TE51)

Alle/All

76-79

O.E

B

19,0

809938

809938

Corolla (KE70 Van & KE76)

Alle/All

2/80-

O.E

B

20,6

809939

809939

Corolla (CE70)

Alle/All

2/82-

O.E

B

19,0

809938

809938

Corolla (TE71)

Alle/All

8/79-

O.E

B

20,6

804507

804507



F/B

Ø

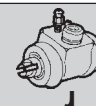
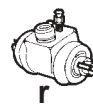

TOYOTA

Corolla (AE80/AE82)

Alle/All	5/83-5/85	O.E	B	19,0	804529	804530	
Alle/All	6/85-87	O.E	B	17,4	804532	804531	874552 U

Corolla (CE80/EE80)

Alle/All	8/83-5/85	O.E	B	19,0	804529	804530	
Alle/All	6/85-87	O.E	B	17,4	804532	804531	874552 U

Corolla (EE90/AE92/CE90)

Alle/All	5/87-4/92	O.E	B	17,4	804532	804531	
----------	-----------	-----	---	------	---------------	---------------	--

Corolla (EE90/AE92/CE90) Wagon

Alle/All	5/87-4/92	O.E	B	19,0	804529	804530	
----------	-----------	-----	---	------	---------------	---------------	--

Corolla (AE95)

1.6 Xli 4x4, 4 WD	8/88-6/92	O.E	B	19,0	804522	804522	
-------------------	-----------	-----	---	------	---------------	---------------	--

Corolla (_E10_)

Alle/All	5/92-4/97	O.E	B	17,4	804532	804531	
Alle/All	5/92-4/97	O.E	B	19,0	804545	804546	
Alle/All	4/97-	O.E	B	19,0	804545	804546	874552 U

Corona

1.8	6/79-7/81	O.E	B	20,6	804533	804533	
-----	-----------	-----	---	------	---------------	---------------	--

Cressida

Alle/All	7/77-3/85	O.E	B	20,6	804533	804533	
----------	-----------	-----	---	------	---------------	---------------	--

Dyna 100

LH80 CH. ->105260	8/85-	O.E	B	20,0	804534	804534	
LH80 CH. 105261->		O.E	B	23,8	804536	804536	

YH81 CH. ->102340

YH81 CH. 102341->	8/85-	O.E	B	20,0	804534	804534	
-------------------	-------	-----	---	------	---------------	---------------	--

Hiace I

Alle/All	2/77-12/84	O.E	B	20,0	804534	804534	
----------	------------	-----	---	------	---------------	---------------	--

Hiace II

Alle/All	3/83-8/85	O.E	B	20,0	804534	804534	
Alle/All	5/85-11/89	O.E	B	23,8	804536	804536	

Hiace III

Alle/All	8/89-8/95	O.E	B	23,8	804536	804536	
----------	-----------	-----	---	------	---------------	---------------	--

Hiace IV

Alle/All	8/95-	O.E	B	23,8	804536	804536	
----------	-------	-----	---	------	---------------	---------------	--

Hilux (2WD)

Alle/All	1/84-	O.E	B	22,2	804541	804541	
----------	-------	-----	---	------	---------------	---------------	--



F/B

Ø

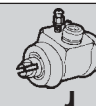
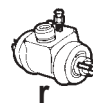

TOYOTA

Hilux (4WD)

2.2, 4 WD

1/87-12/89

O.E

B

19,0

804542

804542

2.4i & 2.4D, 4 WD

8/88-

O.E

B

22,2

804543

804543

Landcruiser

Alle/All

2/74-12/91

O.E

B

25,4

804544

804544

Alle/All

2/74-12/91

O.E

B

23,8

804536

804536

Liteace

Alle/All

10/79-1/92

O.E

B

20,6

804533

804533

Alle/All

92-

O.E

B

Paseo

Alle/All

8/95-7/99

O.E

B

17,4

804532

804531

Picnic

Alle/All

5/96-

O.E

B

20,0

804534

804534

Rav4 I

Alle/All

6/94-6/00

O.E

B

17,4

804557

804557

Starlet

Alle/All

2/78-10/84

O.E

B

19,0

804522

804522

Alle/All

10/84-3/99

O.E

B

17,4

804532

804531

874552 U

Tercel

Alle/All

5/82-1/88

O.E

B

17,4

804532

804531

874552 U

Tercel 4WD (AL2_)

Alle/All, 4 WD

10/82-1/88

O.E

B

19,0

804522

804522

Yaris

Alle/All

4/99-

O.E

B

17,4

804555

804556

TRABANT

P 601

Alle/All

1/66-4/90

F

22,2

805801 U

805801 U

Alle/All

1/66-4/90

B

15,8

805803 U

805803 U

1.1

Alle/All

5/90-12/91

B

19,0

805804 U

805804 U



F/B

Ø

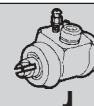
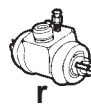

VAUXHALL

Arena

Alle/All 3/98-8/01 B 23,8 803919 803919

Astra

1.2/1.3 Saloon/Hatchback 80-84 DEL B 17,4 803608 803608

1.2/1.3 Saloon/Hatchback 80-84 DEL B 14,3 803620 803620

1.2-1.8 Hatchback CH. ->FE199999 10/84-85 DEL B 17,4 803608 803608

1.2-1.8 Hatchback CH. GE100001-> 85-91 ATE B 17,4 803628 803628

1.2-1.8 Hatchback CH. ->G2502696 10/84-85 DEL B 17,4 803608 803608

1.2-1.8 Hatchback CH. G2502697-> 85-91 ATE B 17,4 803628 803628

Astra HD

Alle/All 80-84 ATE B 19,0 803611 803611

Alle/All 91- ATE B 19,0 803629 803629

Astra

1.6 & 1.8 81-84 ATE B 17,4 803625 803625

1.6 Diesel 81-84 ATE B 17,4 803625 803625

2.0 Hatchback (- 16V) 87-91 ATE B 19,0 803629 803629

Astra Cabriolet Mk II

Alle/All 1/87-8/93 ATE B 17,4 803628 803628

Astra Estate

Alle/All CH. ->FE199999 10/84-85 ATE B 19,0 803619 803619

Alle/All CH. GE100001-> 85-91 ATE B 19,0 803629 803629

Alle/All CH. ->G2502696 10/84-85 ATE B 19,0 803619 803619

Alle/All CH. G2502697-> 85-91 ATE B 19,0 803629 803629

Alle/All CH. ->2518194 80- DEL B 19,0 803609 U 803609 U

Alle/All CH. 2518195-> -84 ATE B 19,0 803619 803619

Astramax

Astramax 85-91 DEL B 19,0 803630 803630

Astra

Alle/All 91-2/98 ATE B 17,4 803628 803628

Astra Mk IV

Alle/All (18) 9/98- B 19,0 803640 803640

Astravan

Astravan 1.3/1.4 CH. ->FE199999 10/84-85 ATE B 19,0 803611 803611

Astravan 1.3/1.4 CH. GE100001-> 85-91 DEL B 19,0 803630 803630

Astravan 1.3/1.4 CH. ->2518194 82- DEL B 19,0 803609 U 803609 U

Astravan 1.3/1.4 CH. 2518195-> -84 ATE B 19,0 803619 803619

Astravan 1.6 & 1.6 Diesel CH. ->FE199999 10/84-85 ATE B 17,4 803625 803625

Astravan 1.6 & 1.6 Diesel CH. GE100001-> 85-91 ATE B 17,4 803631 803631

Astravan 1.6 & 1.6 Diesel 81-84 ATE B 17,4 803625 803625



F/B

Ø

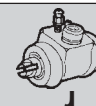
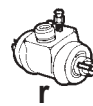

VAUXHALL

Astravan

Astravan 1.7 Diesel

86-91

DEL

B

19,0

803630

803630

Astravan Mk III

Alle/All

1/91-8/98

ATE

B

17,4

803628

803628

Astravan Mk IV

Alle/All (18)

8/98-

B

19,0

803640

803640

Brava Pick-up

Alle/All

6/90-

O.E

B

25,4

801433

801433

Carlton

Alle/All

78-82

ATE

B

19,0

803611

803611

Carlton Estate

Alle/All

78-84

ATE

B

22,2

803616

803616

Carlton Mk II

Alle/All, ABS

10/78-8/86

ATE

B

22,2

803632 U

803632 U

Alle/All CH. F1000189->

10/78-8/86

DEL

B

19,0

803630

803630

Alle/All

10/78-8/86

ATE

B

15,8

803606

803606

Carlton Mk II Estate

Alle/All CH. F1000189->

1/82-8/86

ATE

B

22,2

803632 U

803632 U

Cavalier

1.3 HD

77-81

DEL

B

19,0

803609 U

803609 U

1300

8/77-8/81

ATE

B

15,8

803610

803610

Alle/All (-1300)

3/75-8/81

ATE

B

19,0

803611

803611

Cavalier Mk II

Alle/All CH. ->G6000000

9/81-8/88

DEL

B

17,4

803608

803608

Alle/All CH. G6000001->

9/81-8/88

ATE

B

17,4

803628

803628

2.0i KAT

9/86-8/88

DEL

B

17,4

803623

803623

2.0i KAT

9/86-8/88

ATE

B

19,0

803629

803629

Chevette

Alle/All

3/75-12/85

DEL

B

19,0

803609 U

803609 U

Alle/All

3/75-12/85

LUC

B

19,0

803639

803639

1300

3/75-12/85

ATE

B

19,0

809930

809930

Combo

Alle/All

7/94-10/01

DEL

B

19,0

803630

803630

Alle/All (18)

9/01-

B

19,0

803640

803640

Corsa

Alle/All

3/93-9/00

ATE

B

19,0

803629

803629



F/B

Ø

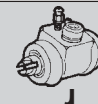
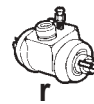

VAUXHALL

Corsa Mk II

Alle/All (18)

9/00-

B

19,0

803640

803640

Firenza

1300

1/71-10/73

LUC

B

17,4

809919

809919

Frontera

Alle/All

3/92-10/98

O.E

B

25,4

801433

801433

Movano

Alle/All

10/98-

BOS

B

23,8

803641

803642

Nova

Alle/All CH. ->G4000000

83-85

B

14,3

803622

803622

Alle/All CH. ->G4000000

83-85

DEL

B

17,4

803623

803623

Alle/All CH. G4000001->

85-

ATE

B

17,4

803628

803628

Tigra

Alle/All

7/94-

ATE

B

19,0

803629

803629

Alle/All (18)

7/94-

B

19,0

803640

803640

Vectra

1.6 & 2.0 DI 16V

10/95-

ATE

B

19,0

803629

803629

Viva

1159/1256

70-78

LUC

B

17,4

809919

809919

1159/1256

72-78

LUC

B

17,4

809919

809919

Zafira

Alle/All

4/99-

B

20,6

803643

803643



F/B

Ø

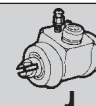
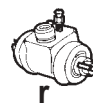

VOLKSVAGEN

181

Alle/All	9/69-2/79	ATE	F	22,2	804716	804716	
Alle/All	9/69-2/79	ATE	B	17,4	804718	804718	

1200 Type I

Alle/All	57-7/64		F	22,2	804714	804714	
Alle/All	57-7/64		B	19,0	804715	804715	
Alle/All	8/64-	ATE	F	22,2	804716	804716	
Alle/All	8/64-12/66	ATE	B	19,0	804717	804717	
Alle/All	1/67-	ATE	B	17,4	804718	804718	

1300 Type I

Alle/All	8/65-74	ATE	F	22,2	804716	804716	
Alle/All	8/65-7/67	ATE	B	19,0	804717	804717	
Alle/All	8/67-74	ATE	B	17,4	804718	804718	

1302 Type I

Alle/All	8/70-7/72	ATE	F	23,8	804719	804719	874725 U
Alle/All	8/70-7/72	ATE	B	17,4	804718	804718	

1303 Type I

Alle/All	8/72-7/74	ATE	F	23,8	804719	804719	874725 U
Alle/All	8/72-7/79	ATE	B	17,4	804718	804718	

1500 Type I

Alle/All	8/66-7/67	ATE	B	19,0	804717	804717	
Alle/All	8/67-70	ATE	B	17,4	804718	804718	

1500 Type 3 Kombi

Alle/All	8/64-65	ATE	B	23,8	804719	804719	874725 U
Alle/All	66-67	ATE	B	22,2	804720	804720	

1500 Type 3 Lim.

Alle/All	63-73	ATE	B	22,2	804720	804720	
----------	-------	-----	---	------	---------------	---------------	--

1600 Type 3

Alle/All	8/65-73	ATE	B	22,2	804720	804720	
----------	---------	-----	---	------	---------------	---------------	--

Caddy I

Alle/All	8/82-7/92	ATE	B	17,4	804706	804706	
----------	-----------	-----	---	------	---------------	---------------	--

Caddy II (Van)

Alle/All, (Aluminium) (18)	11/95-	FAG	B	20,6	804738	804738	
----------------------------	--------	-----	---	------	---------------	---------------	--

Caddy II Pick Up (9U7)

1.6/1.9D, (-ABS)	10/97-	LUC	B	20,6	804304	804304	
1.6/1.9D, ABS	10/97-	O.E	B	19,0	804303	804303	



F/B

Ø

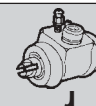
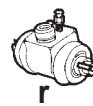

VOLKSWAGEN

Derby

Alle/All (1)	1/77-2/85	ATE	B	14,3	804701	804701
Alle/All (1)	3/85-12/88	ATE	B	15,8	804709	804709
Alle/All (2)	1/77-2/85	ATE	B	17,4	804706	804706
Alle/All (2)	3/85-12/88	LUC	B	19,0	804735	804735

Golf I

Alle/All	4/74-10/83	ATE	B	14,3	804701	804701
Aut.	-10/83	ATE	B	17,4	804706	804706
Gti	-10/83	ATE	B	17,4	804706	804706

Golf II

Alle/All (- 1.6 TD & 1.8)	8/83-91	ATE	B	14,3	804701	804701
1.6 TD	8/83-91	ATE	B	17,4	804706	804706
1.8 & 1.8i Kat, (Aluminium) (18)	8/86-10/91	ATE	B	17,4	804739	804739

Golf II Syncro

Alle/All	8/83-12/91	LUC	B	19,0	804735	804735
----------	------------	-----	---	------	---------------	---------------

Golf III

1.4	10/91-5/98	ATE	B	15,8	804709	804709
1.6, 55 kW.	10/91-	ATE	B	17,4	804706	804706
1.6, 74 kW. CH. ->1S 246940	7/94-	ATE	B	17,4	804706	804706
1.6, 74 kW. CH. 1S 246941->		LUC	B	19,0	804735	804735
1.6, 74 kW. Aut.	7/94-	ATE	B	17,4	804706	804706
1.8 Man. CH. ->1S 246940	11/91-	ATE	B	17,4	804706	804706
1.8 Man. CH. 1S 246941->		LUC	B	19,0	804735	804735
1.8 Aut. CH. ->1S 246940	11/91-	ATE	B	15,8	804709	804709
1.8 Aut. CH. 1S 246941->		ATE	B	17,4	804706	804706
1.8 Syncro CH. ->1S 400000	1/93-		B	20,6	804736	804736
1.8 Syncro, (Aluminium) (18)	1/93-8/97	FAG	B	20,6	804738	804738
1.9 D Ecomatic CH. ->1S 246940	8/93-	ATE	B	15,8	804709	804709
1.9 TD, 55 kW.	11/91-	ATE	B	15,8	804709	804709
1.9D/TD/Tdi/Sdi	11/91-	ATE	B	17,4	804706	804706

Golf III Variant

1.4	7/93-6/95	ATE	B	17,4	804706	804706
1.4	7/95-	LUC	B	19,0	804735	804735
1.6/1.8/2.0	7/93-	LUC	B	19,0	804735	804735
1.9D/TD/Tdi/Sdi	7/93-	LUC	B	19,0	804735	804735

Golf I Cabrio

Alle (1)	-93	ATE	B	14,3	804701	804701
Alle (2)	-93	ATE	B	17,4	804706	804706
Alle, (Aluminium) (18)	-93	ATE	B	17,4	804739	804739



F/B

Ø

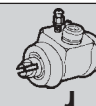
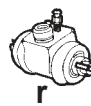

VOLKSWAGEN

Golf III Cabrio

1.6/1.8/1.9 Tdi/2.0 CH. ->1SK016363	7/93-5/98	ATE	B	17,4	804706	804706
1.6/1.8/1.9 Tdi/2.0, (Aluminium) CH. ->1SK016363	7/93-5/98	ATE	B	17,4	804739	804739
1.6/1.8/1.9 Tdi/2.0 CH. 1SK016364-> 1.6	7/93-5/98	LUC	B	19,0	804735	804735
	6/98-	LUC	B	19,0	804735	804735
1.8/1.9 Tdi/2.0 CH. ->1EZSK016363	6/98-	ATE	B	17,4	804706	804706
1.8/1.9 Tdi/2.0, (Aluminium) CH. 1EZSK016364->	6/98-	ATE	B	17,4	804739	804739

Jetta I

Alle/All	8/79-12/83	ATE	B	14,3	804701	804701
1.6 GLi & 1.8	8/79-12/83	ATE	B	17,4	804706	804706

Jetta II

Alle/All (-Syncro)	1/84-12/91	ATE	B	14,3	804701	804701
Alle/All (-Syncro)	1/84-12/91	ATE	B	17,4	804706	804706

Jetta II Syncro

Alle/All	8/87-7/91	LUC	B	19,0	804735	804735
----------	-----------	-----	---	------	---------------	---------------

Kaefer

1.2	1/57-7/65		F	22,2	804714	804714
1.2	1/57-7/65		B	19,0	804715	804715
1.2 & 1.3	8/64-12/69	ATE	F	22,2	804716	804716
Alle/All	1/70-2/76	ATE	F	23,8	804719	804719
1.2/1.3/1.5	1/60-11/73	ATE	B	19,0	804717	804717
Alle/All	1/60-7/79	ATE	B	17,4	804718	804718

LT 28/31

Alle/All	4/75-	ATE	B	25,4	804729	804729
----------	-------	-----	---	------	---------------	---------------

LT 35

Alle/All	4/75-	ATE	B	25,4	804731	804731
----------	-------	-----	---	------	---------------	---------------

LT 40/45

Alle/All (12)	8/78-	ATE	B	25,4	804731	804731
Alle/All (13)	12/82-	FAG	B			

LT 50/55

Alle/All	12/82-	FAG	B			
----------	--------	-----	---	--	--	--

Lupo (6X1, 6E1)

Alle/All	9/98-	ATE	B	17,4	804706	804706
Alle/All, (Aluminium)	9/98-	ATE	B	17,4	804739	804739
Alle/All, (Aluminium)	9/98-	ATE	B	15,8	804740	804740

Passat

1.3	5/73-7/84	ATE	B	14,3	804701	804701
1.3	8/84-7/85	ATE	B	15,8	804709	804709
1.3 HD	8/84-7/85	ATE	B	17,4	804706	804706



F/B

Ø

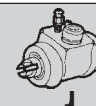
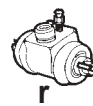

VOLKSWAGEN

Passat

1.5	5/73-8/75	ATE	B	14,3	804701	804701
1.5 Aut	5/73-8/75	ATE	B	17,4	804706	804706
1.5 Diesel	8/77-7/80	ATE	B	14,3	804701	804701
1.5 Aut. Diesel	8/77-7/80	ATE	B	17,4	804706	804706
1.6	9/75-7/81	ATE	B	14,3	804701	804701
1.6	8/81-7/84	ATE	B	15,8	804709	804709
1.6	8/84-3/88	ATE	B	15,8	804709	804709
1.6 (18)	4/88-9/89		B	19,0	804306	804306
1.6	10/89-		B	20,6	804736	804736
1.6i	9/75-7/80	ATE	B	17,4	804706	804706
1.6 Aut.	9/75-7/84	ATE	B	17,4	804706	804706
1.6 Aut. HD	8/84-3/88	ATE	B	17,4	804706	804706
1.6 Diesel	8/80-7/81	ATE	B	14,3	804701	804701
1.6 Diesel	8/81-7/84	ATE	B	15,8	804709	804709
1.6 Diesel	8/84-3/88	ATE	B	14,3	804701	804701
1.6 Aut. Diesel	8/80-7/84	ATE	B	17,4	804706	804706
1.6 Aut. Diesel HD	8/84-3/88	ATE	B	17,4	804706	804706
1.6 TD	12/81-7/84	ATE	B	17,4	804706	804706
1.6 TD	8/84-3/88	ATE	B	17,4	804706	804706
1.6 TD	4/88-10/93		B	20,6	804736	804736
1.8 (- GT)	1/83-7/84	ATE	B	15,8	804709	804709
1.8	8/84-3/88	ATE	B	15,8	804709	804709
1.8	4/88-96		B	20,6	804736	804736
1.8i Aut.	1/83-7/84	ATE	B	17,4	804706	804706
1.8 Aut. HD	8/84-3/88	ATE	B	17,4	804706	804706
1.9	1/81-7/81	ATE	B	15,8	804709	804709
1.9	8/81-7/83	ATE	B	17,4	804706	804706
1.9 Diesel	5/89-10/93		B	20,6	804736	804736
1.9 TD	3/91-96		B	20,6	804736	804736
2.0	8/83-7/84	ATE	B	17,4	804706	804706
2.0i	8/84-3/88	ATE	B	17,4	804706	804706
2.2i	8/85-3/88	ATE	B	17,4	804706	804706
1.6/1.6 TD1.8/1.9 D/1.9 TD, (Aluminium)	2/88-8/96	FAG	B	20,6	804738	804738
Passat Variant						
1.3	5/73-7/85	ATE	B	17,4	804706	804706
1.5	5/73-8/75	ATE	B	17,4	804706	804706
1.5 Diesel	8/77-7/80	ATE	B	17,4	804706	804706
1.6	9/75-3/88	ATE	B	17,4	804706	804706
1.6	4/88-		B	20,6	804736	804736



F/B

Ø

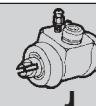
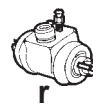

VOLKSWAGEN

Passat Variant

1.6 Diesel & 1.6 TD	8/80-3/88	ATE	B	17,4	804706	804706
1.6 TD	4/88-10/93		B	20,6	804736	804736
1.8	1/83-3/88	ATE	B	17,4	804706	804706
1.8i	4/88-10/93	ATE	B	20,6	804736	804736
1.9	1/81-7/81	ATE	B	15,8	804709	804709
1.9	8/81-7/83	ATE	B	17,4	804706	804706
1.9 TD	3/91-10/93		B	20,6	804736	804736
2.0 & 2.2	8/83-3/88	ATE	B	17,4	804706	804706
1.6/1.6 TD/1.8/1.9 D/1.9 TD, (Aluminium)	2/88-96	FAG	B	20,6	804738	804738

Polo

Alle/All (1)	3/75-2/85	ATE	B	14,3	804701	804701
Alle/All (1)	3/85-9/94	ATE	B	15,8	804709	804709
Alle/All (2)	3/75-2/85	ATE	B	17,4	804706	804706
Alle/All (2)	3/85-9/94	LUC	B	19,0	804735	804735

Polo (6NF)

Alle/All	10/94-	ATE	B	17,4	804706	804706
Alle/All, (Aluminium) (18)	10/94-	ATE	B	17,4	804739	804739
1.9 SDi, ABS	10/94-	LUC	B	19,0	804735	804735

Polo (6N1)

Alle/All	10/94-10/99	ATE	B	17,4	804706	804706
Alle/All, (Aluminium) (18)	10/94-10/99	ATE	B	17,4	804739	804739

Polo (6N2)

Alle/All	10/99-9/01	ATE	B	17,4	804706	804706
Alle/All, (Aluminium) (18)	10/99-9/01	ATE	B	17,4	804739	804739
Alle/All, (-ABS)	10/99-9/01	LUC	B	19,0	804735	804735

Polo Classic (6KV2)

Alle/All	12/95-9/01	LUC	B	19,0	804735	804735
Alle/All, (Aluminium) (18)	12/95-9/01	ATE	B	17,4	804739	804739

Polo Classic 75 (6KV2)

1.4 16V	10/99-9/01	ATE	B	17,4	804706	804706
---------	------------	-----	---	------	---------------	---------------

Polo Variant (6KV5)

Alle/All	5/97-9/01	ATE	B	19,0	804735	804735
----------	-----------	-----	---	------	---------------	---------------

Polo (9N_)

Alle/All, (Aluminium) (18)	10/01-	ATE	B	17,4	804739	804739
----------------------------	--------	-----	---	------	---------------	---------------



F/B

Ø

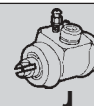
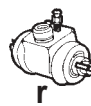

VOLKSWAGEN

Santana (32B)

Alle/All CH. ->ZF127903
Alle/All CH. ->ZF127903
1.6/1.6 D/1.8 CH. ZF127904->

4/93-
4/93-

ATE B 14,3
ATE B 17,4
ATE B 15,8

804701
804706
804709

804701
804706
804709

Scirocco

1.1/1.3
1.3
1.3
1.3

1.5
1.5

1.6
1.6
1.6
1.6

1.8
1.8

74-7/81
8/81-7/83
8/83-10/83
11/83-7/84

74-7/81
8/81-7/83

75-7/81
8/81-7/83
8/83-10/83
11/83-

8/83-10/83
11/83-

ATE B 14,3
ATE B 17,4
ATE B 14,3
ATE B 17,4

ATE B 14,3
ATE B 17,4

ATE B 14,3
ATE B 17,4
ATE B 14,3
ATE B 17,4

ATE B 14,3
ATE B 17,4

804701
804706
804701
804706

804701
804706

804701
804706
804701
804706

804701
804706

804701
804706
804701
804706

804701
804706

804701
804706
804701
804706

804701
804706

Alle/All i mod.
Aut.

ATE B 17,4
ATE B 17,4

804706
804706

804706
804706

Taro

Alle/All 4/89-3/97

O.E B 22,2

804541

804541

Transporter T2

Alle/All 8/68-7/79

ATE B 23,8

804728

804728

Transporter T3

Alle/All 5/79-7/92

ATE B 23,8

804728

804728

Transporter T4

Alle/All 7/90-

B 20,6

804737

804737

Vento

1.4/1.6/1.8/1.9 D/1.9 TD CH. ->1S430000 1/92-9/98
1.4/1.6/1.8/1.9 D/1.9 TD (Aluminium) CH ->1S430000 1/92-9/98
1.6/1.8/1.9 D/1.9 TD/1.9 TDi CH. 1S430001-> 1/92-9/98

ATE B 17,4
ATE B 17,4
LUC B 19,0

804706
804739
804735

804706
804739
804735



F/B

Ø

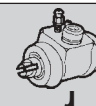
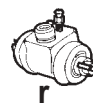

VOLVO

Amazon 122S, B18

Alle/All

5/61-6/64

LUC

B

25,4

804804

804804

Alle/All (3)

5/61-6/64

LUC

B

899901

899901

Amazon B18

Alle/All

6/64-6/65

LUC

B

25,4

804804

804804

Alle/All

7/65-9/68

LUC

B

22,0

804805

804805

Amazon Estate B18

Alle/All

6/64-9/68

LUC

B

25,4

804804

804804

Alle/All (3)

6/64-9/68

LUC

B

899901

899901

Amazon B20

Alle/All

9/68-70

LUC

B

22,2

804806

804806

340

L/DL/GL/Diesel

8/82-

LUC

B

19,0

809920

809920

DL 1.7

6/85-

LUC

B

20,6

804808

804808

343/345

L/DL/GL

2/76-

LUC

B

19,0

809920

809920

360

GL/GLE/GLS/GLT

8/82-

LUC

B

20,6

804808

804808

440/460

Alle/All

9/88-

LUC

B

20,6

804812

804811



F/B

Ø

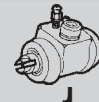
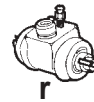

WARTBURG

353

Alle/All

6/66-2/75

F

25,4

804901 U

804902 U

Alle/All

6/66-2/75

B

25,4

804903 U

804903 U

Alle/All

2/75-5/91

B

19,0

804904 U

804904 U

YUGO

101

1100

6/73-12/93

OE

B

19,0

802304

802304



F/B

Ø

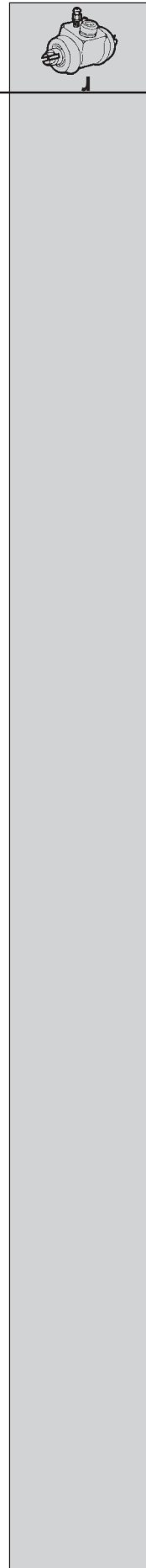
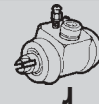
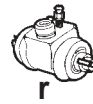

Anvendelsesliste
Buyer's guide
Nummerische Liste



				Ø
801001	Alfa Romeo	33	7/83-8/86	17,4
801002	Alfa Romeo	33	7/83-8/86	17,4
801005	Alfa Romeo	33	9/85-9/94	17,4
801006	Alfa Romeo	33	9/85-9/94	17,4
801007	Alfa Romeo	33/Arna	84-89	19,0
801008	Alfa Romeo	33/Arna	84-89	19,0
801201	Rover Group	Austin Mini MK I	67-84	24,0
801202	Rover Group	Austin Mini MK I	67-84	24,0
801204	Rover Group	Austin Mini MK I	-7/78	14,0
801205	Rover Group	Austin/Austin MK II & III/MGB GT/MGB Tourer & Roadster	62-82	20,3
801207	Rover Group	Austin Maxi	11/78-81	14,3
801214	Rover Group	Austin Allegro	73-84	14,3
801215	Rover Group	Morris Minor	56-71	24,0
801216	Rover Group	Morris Minor	56-71	24,0
801217	Rover Group	Morris Minor	62-71	19,0
801220	Rover Group	Austin/Austin MK I / II & III	5/65-75	18,0
801222	Rover Group	Austin Princess	4/76-10/82	14,3
801225	Rover Group	Austin Metro/Rover 100/Rover Maestro	10/80-1/95	17,4
801226	Rover Group	Austin Maestro	83-95	15,8
801227	Rover Group	Austin Maestro	83-95	15,8
801228	Rover Group	Austin Montego	4/84-8/91	17,4
801229	Rover Group	Austin Montego	4/84-8/91	17,4
801409	Bedford	CF Van	77-	23,8
801410	Bedford	CF Van	77-	23,8
801432	Isuzu	Trooper	83-	22,2
801433	Isuzu	Campo(TFR/TFS)/KB/KBD/Trooper	81-12/91	25,4
	Opel	Campo/Frontera A	8/91-10/98	25,4
	Vauxhall	Brava Pick-up/Frontera	6/90-	25,4
801502	BMW	02 Series(E10)/2000-3.2 (E9)/5 Series (E12)	70-5/81	22,2
801503	BMW	02 Series (E6)&(E10)/1500-2000 Series	66-75	17,4
801504	BMW	02 Series (E6)&(E10)/1500-2000 Series	9/67-7/77	15,8
801506	BMW	3 Series (E30)	9/82-10/93	20,6
801507	BMW	5 Series (E28)	9/84-6/90	20,6
801508	BMW	3 Series (E30)	9/85-6/94	22,2
801509	BMW	5 Series (E34)	8/89-9/95	23,8
801510	BMW	3 Series (E36)	9/90-8/00	23,8
801511	BMW	3 Series (E36)	3/94-8/00	22,2
801813	Talbot	1307-1510/Horizon/Solara	7/75-7/86	20,6
801820	Talbot	Avenger/Simca Sunbeam	2/70-7/81	18,0
801909	Citroen	2 CV/Dyane/Mehari	6/70-	28,6
801910	Citroen	2 CV/Dyane/Mehari	6/70-	17,4
801911	Citroen	2 CV/3 CV/AMI & AMI Break/Dyane/Mehari	7/69-	16,0
801918	Citroen	LNA/Visa	9/78-	20,6
801918	Peugeot	104		20,6
801919	Citroen	AX	9/86-12/98	19,0
801920	Citroen	AX	9/86-12/98	19,0
801921	Citroen	AX	9/86-12/98	19,0
801923	Citroen	ZX	3/91-8/92	20,6
801924	Citroen	ZX	3/91-8/92	20,6
801925	Citroen	Visa	84-89	22,2
801926	Citroen	Evasion/Jumpy	6/94-	19,0
	Fiat	Scudo/Ulysse	6/94-	19,0
	Lancia	Zeta	5/95-9/02	19,0
	Peugeot	806/Expert	6/94-	19,0

**Anvendelsesliste
Buyer's guide
Numerische Liste**



				Ø
801927	Citroen	Xsara/ZX	2/94-	20,6
	Peugeot	306/306 Break	5/93-	20,6
801928	Citroen	C 25	2/89-	22,2
	Fiat	Talento	9/89-	22,2
	Peugeot	J 5	2/89-	22,2
801929	Citroen	Berlingo/Xsara	7/96-	22,2
	Peugeot	Partner	6/96-	22,2
801930	Citroen	Saxo/Xsara/ZX	7/95-	20,6
	Peugeot	106 II/306	5/95-	20,6
	Renault	Laguna/Megane Grandtour/Megane Scenic/Scenic	7/95-	20,6
801931	Citroen	AX	5/91-12/96	
	Renault	Twingo	3/94-	
801932	Citroen	Xsara	10/97-	22,0
	Peugeot	306 Break	2/97-	22,0
801933	Citroen	C3	02/02-	19,0
801934	Citroen	C3	02/02-	19,0
801935	Citroen	C3	02/02-	20,8
802201	Nissan	Cherry (E10)/Datsun 100A	9/70-8/80	17,4
802202	Nissan	Cherry (E10)/Datsun 100A	9/70-8/80	17,4
802209	Nissan	1000 B10/1200 B110	66-73	20,0
802211	Nissan	Datsun (120)	5/73-11/77	20,0
802212	Nissan	Datsun (120)	5/73-11/77	20,0
802217	Nissan	Bluebird (T72/T12)/Bluebird (U11/WU11)/Datsun (140/160/180)/ Prairie (M11)/Primera Wagon (W10)/Silvia (S110)/ Sunny (140Y,150Y)/Vanette(C22)	1/70-3/98	20,6
802222	Nissan	Cherry (N12)/Sunny I (B11)/Sunny II (N13,B12)	3/82-10/91	17,4
802224	Nissan	Prairie (M10)/Stanza (T11)	8/81-12/87	17,4
802225	Nissan	Micra (K10)	12/82-7/92	15,9
802226	Nissan	Patrol (K160/W160)/Patrol (K260/W260)	11/79-9/89	22,2
802229	Nissan	Pick up (720)/Urvan (E23)	1/82-3/86	17,4
802231	Nissan	Pick up (720)	7/80-11/81	17,0
802232	Nissan	Pick up (720)	4/83-3/86	16,0
802233	Nissan	Pick up (720)	12/81-3/83	14,3
802234	Nissan	Pick up (D21)	9/85-8/91	17,4
802235	Nissan	Pick up (D21)/Urvan (E23)	9/85-8/88	19,0
802236	Nissan	Pick up (D21)	9/85-7/89	15,0
802237	Nissan	Prairie (M11)/Prairie (NM10)/Vanette Bus (KC120)/Vanette Kasse (C22)	1/83-1/95	19,0
802238	Nissan	Bluebird (T72/T12)/Bluebird (U11/WU11)/Laurel/Prairie (M11)/ Prairie (NM10)/Silvia (S12)	7/81-12/92	22,2
802239	Nissan	Primera (P10)	10/90-1/96	20,6
802240	Nissan	Primera (P10)	10/90-1/96	20,6
802241	Nissan	100 NX (B13)/Almera I (N15)/Sunny III (N14)	3/90-7/00	15,8
802242	Nissan	Prairie (M11)/Sunny III Wagon (Y10)/Vanette Bus (C22)	11/90-	17,4
802243	Nissan	Urvan (E24)	1/87-	20,6
802244	Nissan	Micra (K11)	8/92-2/03	17,4
802245	Nissan	Patrol (K260/W260)/Patrol I (Y60)/Patrol II (Y61)	9/88-	25,4
802246	Nissan	Pick up (D21)	8/89-	20,6
802247	Ford	Maverick	2/93-8/96	22,2
	Ford USA	Maverick	2/93-8/96	22,2
	Nissan	Terrano II (R20)	1/90-	22,2
802248	Ford	Maverick	2/93-8/96	23,8
	Ford USA	Maverick	2/93-4/98	23,8
	Nissan	Serena (C23M)/Terrano II (R20)/Vanette Cargo	1/90-	23,8
802249	Nissan	Primera (P11)	9/96-	

Anvendelsesliste
Buyer's guide
Nummerische Liste



				Ø
802303	Fiat	600/850	3/55-73	22,2
802304	Autobianchi	A 112	71-12/85	19,0
802304	Fiat	126/127/128/147/500/600/850/Fiorino (147)	3/55-6/96	19,0
802304	Lada	1200-1600	1/70-12/78	19,0
802304	Lancia	A112	3/81-10/82	19,0
802304	Seat	Fura	1/82-12/86	19,0
802304	Yugo	101	6/73-12/93	19,0
802306	Lada	110/111/112/1200-1600/Nova/Samara	1/78-	20,6
802313	Fiat	131/132	10/74-8/82	22,2
802320	Fiat	Ritmo I	5/78-83	17,4
802320	Lancia	Delta I	9/79-8/92	17,4
802321	Lada	1200-1600/Niva	12/76-	20,6
802323	Fiat	Daily 35	79-	17,0
802324	Fiat	900/Panda	1/78-1/86	15,8
802328	Autobianchi	Y 10	3/85-	19,0
802328	Fiat	127/147/Cinquecento/Duna/Fiorino (146 Uno)/Fiorino (147)/Panda/Regata/Ritmo/Ritmo II/Seicento/Uno	1/80-	19,0
802328	Lancia	A112/Delta I/Prisma/Y10 (156)	9/79-12/95	19,0
802328	Seat	Marbella	8/86-10/98	19,0
802329	Fiat	Panda	9/82-7/84	15,7
802331	Fiat	Ritmo I	6/82-11/82	17,4
802331	Lancia	Delta I/Prisma	9/79-8/92	17,4
802331	Seat	Ibiza I/Malaga/Ronda	7/82-	17,4
802333	Fiat	Tipo	2/88-2/93	15,0
802334	Fiat	Tempra/Tipo	2/88-8/96	17,4
802335	Fiat	Tempra/Tipo	2/88-2/93	19,0
802335	Lancia	Dedra	8/89-7/99	19,0
802336	Fiat	Punto	7/93-	20,6
802336	Lancia	Y (840A)	3/96-	20,6
802337	Fiat	Punto	7/93-	20,6
802337	Lancia	Y (840A)	3/96-	20,6
802338	Alfa Romeo	145/146	10/94-1/01	22,2
802338	Fiat	Tempra/Tipo	3/93-	22,2
802338	Lancia	Delta II	6/93—8/99	22,2
802340	Citroen	Jumper	2/94-4/02	25,4
802340	Fiat	Ducato	2/94-4/02	25,4
802340	Peugeot	Boxer 10 &14	3/94-4/02	25,4
802341	Citroen	Jumper	2/94-4/02	27,0
802341	Fiat	Ducato	2/94-4/02	27,0
802341	Peugeot	Boxer 14	3/94-4/02	27,0
802342	Citroen	Jumper	2/94-4/02	28,6
802342	Fiat	Ducato	2/94-4/02	28,6
802342	Peugeot	Boxer 18	3/94-4/02	28,6
802343	Alfa Romeo	145	9/94-1/01	20,6
802343	Fiat	Marea/Multipla/Palio (Weekend)/Tempra/Tipo	3/92-	20,6
802344	Fiat	Brava/Bravo/Marea	6/95-	22,2
802345	Fiat	Brava/Bravo/Marea	6/95-	22,2
802346	Fiat	Punto/Regata	10/83-	20,6
802347	Fiat	Punto	8/99-	22,0
802348	Fiat	Doblo	3/01-	20,64
802349	Fiat	Fiorino (146 Uno)	1/93-	20,64
802350	Fiat	Palio	4/96-	19,05
802351	Fiat	Siena	4/96-	19,05
802505	Ford	Taurus	62-71	17,4

**Anvendelsesliste
Buyer's guide
Numerische Liste**



802506	Ford	Cortina/Escort III & IV & VI/Focus/Orion/Orion II/Puma/Taurus	8/71-	19,0
802507	Ford	Capri/Cortina/Escort II & III & IV/Granada/Ka/Orion/Taurus	1/74-	17,4
802507	Mazda	121 III (JASM,JBSM)	3/96-	17,4
802508	Ford	Cortina/Taurus	74-7/82	19,0
802509	Ford	Cortina/Focus/Granada/Sierra	70-	20,6
802513	Ford	Courier/Escort '81/Escort III/Escort IV/Orion II/Fiesta IV/Granada/Orion/Sierra	1/74-	22,2
802516	Ford	Capri/Escort II	11/74-8/80	20,6
802518	Ford	Capri/Cortina	66-10/74	17,4
802522	Ford	Capri	11/74-6/76	18,0
802523	Ford	Fiesta I	6/76-7/83	17,4
802524	Ford	Fiesta I	6/76-7/83	15,8
802530	Fiat	Daily I 35-12	1/90-4/96	19,0
802530	Ford	Transit	9/68-12/70	19,0
802531	Ford	Transit	7/76-	20,3
	Rover Group	MG RV8	93-	20,3
802532	Ford	Transit	76-85	25,0
802533	Ford	Transit	76-85	25,0
802536	Ford	Sierra	8/82-12/86	20,6
802537	Ford	Escort II	12/74-8/80	17,8
802539	Ford	Fiesta II	8/83-4/89	17,4
802540	Ford	Transit	86-91	20,3
802541	Ford	Transit	86-91	22,2
802542	Ford	Transit	86-91	22,2
802543	Ford	Transit	86-91	22,2
802544	Ford	Sierra/Transit	86-	23,8
802545	Ford	Sierra/Transit	86-	23,8
802546	Ford	Transit	86-91	25,4
802547	Ford	Transit	86-91	25,4
802549	Ford	Fiesta III	2/89-95	17,4
802550	Ford	Fiesta III	2/89-95	22,2
802551	Ford	Sierra	1/87-	22,0
802552	Ford	Escort IV/Orion III/Escort VII/Focus/Sierra	1/87-	20,6
	Land Rover	Freelander	2/98-	20,6
802553	Ford	Escort IV/Orion III/Escort VII/Fiesta IV	8/90-	19,0
	Mazda	121 III (JASM,JBSM)	3/96-	19,0
802554	Ford	Escort IV/Orion III/Escort VII/Focus	8/90-	22,2
802555	Ford	Fiesta II	2/84-4/89	15,0
802556	Ford	Fiesta II	2/84-4/89	20,6
802557	Ford	Fiesta III	5/89-12/94	19,0
802558	Ford	Fiesta I	10/81-7/83	19,0
802559	Ford	Transit	88-	20,3
802560	Ford	Transit	88-	20,3
802561	Ford	Mondeo	1/93-5/94	20,6
802562	Ford	Mondeo	1/93-11/00	22,2
802563	Ford	Transit	9/91-	22,2
802564	Ford	Transit	9/91-	20,6
802565	Ford	Transit	9/91-	25,4
802566	Ford	Mondeo	6/94-11/00	22,2
802567	Ford	Fiesta V/Ka	11/01-	19,05
802568	Ford	Transit	3/00-	25,4
802601	Honda	Accord/Civic	72-80	17,4
802602	Honda	Civic	76-80	15,9
802605	Honda	Accord	79-81	19,0
802606	Honda	Accord/Aerodeck	86-	20,6

**Anvendelsesliste
Buyer's guide
Numerische Liste**



				Ø
802607	Honda	Civic	88-	19,0
802608	Honda	Accord	82-85	19,0
802609	Honda	Civic/Jazz (AA)	82-10/86	19,0
802610	Honda	Civic/Jazz (AA)	82-10/86	19,0
802611	Honda	Civic	84-89	19,0
802612	Honda	Civic	84-89	19,0
802613	Honda	Civic/HR-V	90-	19,0
802614	Honda	Civic/HR-V	90-	19,0
802615	Honda	Civic	92-	19,0
802616	Honda	Civic	92-	19,0
802617	Honda	Accord	90-92	19,0
802618	Honda	Accord	90-92	19,0
803002	Mitsubishi	L300/Pajero I	9/81-	20,6
803003	Mitsubishi	L300/Pajero I	9/81-	20,6
803004	Mitsubishi	Colt I (C1_A)/Colt II (C1_A)/Colt III (C5_A)/Lancer III/ Lancer IV (C6_A/C7_A)/Space Runner/Space Wagon	12/78-8/99	19,0
803011	Mitsubishi	Cordia (A21_A)/Galant III (E1A_)/Galant IV (E3A_)/Lancer V (CD4A)/Tredia	9/82-	17,4
803012	Mitsubishi	L200 (K_4T)/L300/Pajero I/Space Gear	5/86-	22,2
803013	Mitsubishi	L200 (K_4T)/L300/Pajero I/Space Gear	5/86-	22,2
803014	Mitsubishi	L200 (K_4T)/L200 (K6_T)/Pajero II	11/86-	23,8
803015	Mitsubishi	L200 (K_4T)/L200 (K6_T)/Pajero II	11/86-	23,8
803016	Mitsubishi	Lancer III (Wagon)	1/84-6/92	20,6
803017	Mitsubishi	Colt III (C5_A)/Colt IV (CA_A)/Colt V (CJ_A)/Lancer IV (C6_A/C7_A)/ Lancer V (CB/D_A)/Lancer VI/Space Runner	6/90-	19,0
803018	Mitsubishi	Colt V (CJ_A)/Galant IV (E3A_)/Lancer VI	7/89-	17,4
803019	Mitsubishi	Carisma/Space Star	6/95-9/98	??
803020	Mitsubishi	Space Star	10/98-5/00	19,05
803201	Mazda	1300/616	70-2/78	19,0
803202	Mazda	1300/1600/1800/818	69-8/76	17,0
803205	Mazda	1000/1300/323 I (FA)	1/75-5/80	19,0
803206	Mazda	626 I (CB)/929	7/75-12/80	20,6
803207	Mazda	626 I (CB)/929	7/75-12/80	20,6
803209	Mazda	929 L	4/78-9/80	22,0
803215	Mazda	323 II (BD)	11/80-10/89	17,4
803217	Mazda	323 I Wagon (FA)	5/78-5/86	19,0
803220	Mazda	B-Serie	10/81-84	22,2
803221	Mazda	626 II (GC)	11/82-9/87	19,0
803223	Mazda	B-Serie/E 2000/E 2200	1/84-	19,0
803225	Mazda	E 2000/E 2200	1/84-	17,4
803226	Mazda	E 2000/E 2200	1/84-	17,4
803227	Mazda	323 C IV (BG)/323 F IV (BG)/323 S IV (BG)/626 III (GD)/626 III (GV)/ 626 IV (GE)/626 V (GF)/MX3	6/87-	17,4
803228	Mazda	323 III (BF)/323 III Wagon (BW)	8/85-3/93	17,4
803229	Mazda	323 C V (BA)/323 F V (BA)/323 P V/323 S V (BA)	7/94-	19,0
803230	Mazda	121 I&II (DA&DB)	10/87-3/96	15,9
803231	Mazda	Demio	8/98-	17,46
803307	BMW	3 Series (E21)	67-	22,0
803307	MB	Hanomag	67-	22,0
803312	MB	T1 (601/602)	4/77-2/96	18,8
803313	MB	MB 100 Series	2/88-2/96	25,4
803314	MB	GD (W460)/GD (W461)/GD (W463)	3/79-	17,5
803315	MB	A-Klasse	7/97-	17,50
803316	MB	A-Klasse	7/97-	19,05
803317	Smart	Cabrio/City Coupe/Crossblade/Roadstar/Roadstar coupe	7/98-10/99	17,46

**Anvendelsesliste
Buyer's guide
Numerische Liste**



803318	Smart	Cabrio/City Coupe/Crossblade/Roadstar/Roadstar coupe	7/98-10/99	17,46
803319	Smart	Cabrio/City Coupe/Crossblade/Roadstar/Roadstar coupe	11/99-	22,0
803320	Smart	Cabrio/City Coupe/Crossblade/Roadstar/Roadstar coupe	11/99-	22,0
803401	Hyundai	Accent	10/94-1/00	19,0
803402	Hyundai	Accent	10/94-1/00	19,0
803403	Hyundai	H 100	7/93-	20,6
803404	Hyundai	H 100	7/93-	20,6
803405	Hyundai	Coupe/Lantra I/Lantra II/Sonata	10/90-	19,0
803406	Hyundai	Coupe/Lantra I/Lantra II/Sonata	10/90-	19,0
803407	Hyundai	Pony/S Coupe	7/90-	20,6
803408	Hyundai	Pony/S Coupe	7/90-	20,6
803409	Hyundai	Pony/S Coupe	10/89-6/92	20,6
803411	Hyundai	Atos	2/98-	
803412	Hyundai	Atos	2/98-	
803501	Kia	Sephia	9/93-	19,0
803502	Kia	Sportage	4/94-6/97	20,64
803503	Kia	Pregio	10/97-	19,05
803504	Kia	Pregio	10/97-	19,05
803505	Kia	Sportage	6/97-	20,64
803603	Opel	Kadett A/Kadett B/Kadett C/Olympia A	62-7/79	15,8
803604	Opel	Kadett B/Kadett C	65-7/79	23,8
803605	Opel	Kadett B/Kadett C	65-7/79	23,8
803606	Opel	Ascona A/Kadett B/Manta A/Olympia A/Rekord B/C/Rekord D/Rekord E	65	15,8
	Vauxhall	Carlton Mk II	10/78-8/86	15,8
803608	Opel	Kadett D	82-	17,4
	Vauxhall	Astra/Cavalier Mk II	80-8/88	17,4
803609	Opel	Kadett D	8/79-	19,0
	Vauxhall	Astra Estate	3/75-	19,0
803610	Opel	Ascona A/Ascona B/Manta A	70-	15,8
	Vauxhall	Cavalier	8/77-8/81	15,8
803611	Opel	Ascona A&B/Kadett D/Manta A&B/Rekord D&E	72-	19,0
	Vauxhall	Astra HD/Astravan/Carlton/Cavalier	3/75-85	19,0
803616	Opel	Commodore B&C/Rekord E/Rekord E Kombi	1/72-	22,2
	Vauxhall	Carlton Estate	78-84	22,2
803619	Opel	Kadett D/Kadett E Kombi	-7/85	19,0
	Vauxhall	Astra Estate/Astravan	-85	19,0
803620	Opel	Kadett D&E	8/79-85	14,3
	Vauxhall	Astra	80-84	14,3
803622	Opel	Corsa A	9/82-7/86	14,3
	Vauxhall	Nova	83-85	14,3
803623	Opel	Ascona C/Corsa A/Kadett D&E	8/79-7/86	17,4
	Vauxhall	Cavalier Mk II/Nova	83-8/88	17,4
803625	Opel	Commodore A/Kadett D/Kadett E Kombi	8/67-7/85	17,4
	Vauxhall	Astra/Astravan	81-85	17,4
803627	Opel	Corsa A/Kadett E	85-	14,3
803628	Daewoo	Lanos	5/97-	17,4
	Opel	Ascona C/Astra F/Corsa A/Kadett E	85-	17,4
	Vauxhall	Astra/Astra Cabriolet Mk II/Astravan Mk III/Cavalier Mk II/Nova	85-	17,4
803629	Daewoo	Espero/Lanos/Nexia	2/95-	19,0
803629	Opel	Ascona C/Astra F/Astra F Caravan/Kombi/Astra G/Corsa B/Corsa C/Kadett E/Kadett E Kombi/Tigra/Vectra A&B	8/85-	19,0
	Vauxhall	Astra/Astra Estate/Astra HD/Cavalier Mk II/Corsa/Tigra/Vectra	85-	19,0
803630	Opel	Combo (71_)/Kadett E Kombi/Rekord E		19,0
	Vauxhall	Astramax/Astravan/Carlton Mk II/Combo	10/78-10/01	19,0

**Anvendelsesliste
Buyer's guide
Numerische Liste**



				Ø
803631	Opel	Kadett E Kombi	8/85-9/91	17,4
	Vauxhall	Astravan	85-91	17,4
803632	Opel	Rekord E/Rekord E Kombi		22,2
	Vauxhall	Carlton Mk II/Carlton Mk II Estate	10/78-8/86	22,2
803639	Vauxhall	Chevette	3/75-12/85	19,0
803640	Opel	Astra F/Astra F Caravan/Kombi/Astra G/Combo (Kasse/Wagon)/ Combo Tour/Corsa B&C/Tigra/Vectra A&B	9/88-	19,0
803640	Vauxhall	Astra Mk IV/Astravan Mk IV/Combo/Corsa Mk II/Tigra	9/90-	19,0
803641	Opel	Movano	7/98-	23,81
	Renault	Master II	7/98-	23,81
	Vauxhall	Movano	10/98-	23,81
803642	Opel	Movano	7/98-	23,81
	Renault	Master II	7/98-	23,81
	Vauxhall	Movano	10/98-	23,81
803731	Peugeot	205 I & II/205 Kasse	2/83-	19,0
803732	Peugeot	205 I & II/205 Kasse	2/83-	19,0
803739	Peugeot	205 I & II/205 Kasse	2/83-	19,0
803740	Peugeot	205 I & II/205 Kasse	2/83-	19,0
803741	Peugeot	309 II	7/89-12/93	20,6
803742	Peugeot	309 II	7/89-12/93	20,6
803743	Peugeot	405 I & II	1/87-10/95	20,6
803744	Peugeot	405 I & II	1/87-10/95	20,6
803745	Peugeot	504 Break/Cabriolet/Coupe/Pick up/505 Break	4/71-12/93	22,2
	Renault	Espace II/Espace III/Safrane I	5/92-	22,2
803746	Peugeot	205 I & II	12/84-9/98	19,0
803747	Citroen	Saxo	3/96-	19,0
	Peugeot	106 I&II	9/91-	19,0
803748	Citroen	Saxo	3/96-	19,0
	Peugeot	106 I&II	9/91-	19,0
803749	Peugeot	106 I	9/91-4/96	19,0
803750	Peugeot	406	11/95-	20,6
803751	Peugeot	406	11/95-	20,6
803752	Peugeot	406	11/95-	20,6
803753	Peugeot	406	11/95-	20,6
803754	Peugeot	405 I & II/405 II Break	1/87-10/96	20,6
803755	Citroen	C 2/Saxo/Xsara	3/96-	20,6
803755	Peugeot	106 II/206/306	3/96-	20,6
803901	Renault	4/5/6	10/62-6/90	23,8
803902	Renault	4/5/6	10/62-6/90	23,8
803903	Renault	4/5	10/62-	19,0
803904	Renault	4/5/6	8/70-6/90	22,2
803905	Renault	4/5/6	8/70-6/90	22,2
803906	Renault	4	10/62-6/90	21,0
803910	Dacia	1310	5/83-	
803911	Renault	12/15/16/17	9/65-10/80	22,0
803917	Renault	18 Break/Fuego/Trafic		22,0
803919	Opel	Arena/Frontera A	3/92-8/01	23,8
	Renault	Trafic	3/80-	23,8
	Vauxhall	Arena	3/98-8/01	23,8
803922	Renault	12	10/69-8/80	22,2
803925	Renault	Clio I	4/91-9/98	20,6
803926	Daewoo	Lanos	5/97-	19,0
	Renault	Clio I	4/91-9/98	20,6
803927	Renault	19 I	1/88-12/92	20,6

**Anvendelsesliste
Buyer's guide
Numerische Liste**



				Ø
803928	Renault	19 I	1/88-12/92	20,6
803929	Citroen	Xsara/ZX	9/92-	20,6
	Peugeot	306	5/93-	20,6
	Renault	19 I&II	4/91-6/96	20,6
803930	Citroen	Xsara/ZX	9/92-	20,6
	Peugeot	306	5/93-	20,6
	Renault	19 I&II	4/91-6/96	20,6
803931	Renault	Express (Rapid)	1/89-8/98	20,6
803932	Renault	Express (Rapid)	1/89-8/98	20,6
803933	Renault	20/25/30	10/75-12/93	22,0
803934	Renault	20/25/30	10/75-12/93	22,0
803935	Renault	20/25/30	10/75-12/93	23,8
803936	Renault	20/25/30	10/75-12/93	23,8
803938	Renault	Express (Rapid)	86-12/88	22,0
803940	Renault	5 Super/Clio I	6/87-3/91	20,6
803941	Renault	5 Super/Clio I	6/87-3/91	20,6
803944	Renault	21	6/87-3/91	22,0
803945	Renault	21	6/87-3/91	22,0
803946	Renault	21	4/91-	22,0
803947	Renault	21	4/91-	22,0
803948	Renault	19 I&II	1/88-6/96	20,6
803949	Renault	19 I&II	1/88-6/96	20,6
803950	Renault	Megane	11/95-	17,4
803951	Renault	Clio I	6/90-3/91	20,6
803952	Renault	Clio I	6/90-3/91	20,6
803953	Renault	Clio I	4/91-9/98	20,6
803954	Renault	Clio I	4/91-9/98	20,6
803955	Renault	19 I&II	1/88-6/96	19,0
803956	Renault	19 I&II	1/88-6/96	19,0
803957	Renault	Twingo	3/93-	20,6
803958	Renault	Twingo	3/93-	20,6
803959	Renault	Laguna	1/94-	19,0
803960	Renault	Clio II/Twingo	9/98-	17,8
803961	Renault	Laguna (Nevada)	7/86-6/95	22,0
803962	Renault	Laguna (Nevada)	7/86-6/95	22,0
803963	Renault	Kangoo	3/98-	
803964	Renault	Kangoo	3/98-	
803965	Renault	Megane	1/99-	19,0
803966	Renault	Clio II	9/98-	
803967	Renault	Clio II	9/98-	
804001	Rover Group	Rover 200/Triumph Acclaim	-9/89	19,0
804002	Rover Group	Rover 200/Triumph Acclaim	-9/89	19,0
804301	Skoda	105/120/130	8/76-10/91	19,0
804302	Skoda	Favorit/Rapid	2/83-12/92	19,0
804303	Skoda	Favorit/Felicia I-II/Felicia I-II Pick-up	1/93-	19,0
	Volkswagen	Caddy II Pick Up (9U7)	10/97-	19,0
804304	Skoda	Felicia I-II	96-6/01	20,6
	Volkswagen	Caddy II Pick Up (9U7)	10/97-	20,6
804305	Skoda	Felicia I-II Kombi/Felicia I-II Pick-up	8/95-	22,2
804306	Seat	Ibiza III (6K1)	8/99-2/02	19,0
	Skoda	Fabia	12/99-	19,0
804401	Subaru	Leone I	3/79-10/84	14,3
804507	Toyota	Corolla (KE)&(_E7_)	10/72-10/83	20,6
804522	Toyota	Corolla (AE95)/Starlet/Tercel 4WD (AL2_)	2/78-6/92	19,0

**Anvendelsesliste
Buyer's guide
Numerische Liste**



804529	Toyota	Camry/Carina II/Celica/Corolla (_E8_)&(_E9)	2/83-93	19,0
804530	Toyota	Camry/Carina II/Celica/Corolla (_E8_)&(_E9)	2/83-93	19,0
804531	Toyota	Carina II/Corolla/Corolla (_E8_)&(_E9)/Paseo/Starlet/Tercel	5/82-7/99	17,4
804532	Toyota	Carina II/Corolla/Corolla (_E8_)&(_E9)/Paseo/Starlet/Tercel	5/82-7/99	17,4
804533	Toyota	Corona/Cressida/Liteace	7/77-1/92	20,6
804534	Toyota	Dyna 100/Hiace I&II/Picnic	2/77-	20,0
804536	Toyota	Dyna 100/Hiace II&III&IV/Landcruiser		23,8
804541	Toyota	Hilux (2WD)	1/84-	22,2
	Volkswagen	Taro	4/89-3/97	22,2
804542	Toyota	Hilux (4WD)	1/87-12/89	19,0
804543	Toyota	Hilux (4WD)	8/88-	22,2
804544	Toyota	Landcruiser	2/74-12/91	25,4
804545	Toyota	Carina E/Corolla (_E10_ & _E11_)	4/92-1/02	19,0
804546	Toyota	Carina E/Corolla (_E10_ & _E11_)	4/92-1/02	19,0
804547	Toyota	Carina E/Celica	3/90-	19,0
804548	Toyota	Carina E/Celica	3/90-	19,0
804549	Toyota	Carina E	3/93-9/97	19,0
804550	Toyota	Carina E	3/93-9/97	19,0
804551	Toyota	Carina E	4/92-9/97	
804552	Toyota	Carina E	4/92-9/97	
804553	Toyota	Avensis	9/97-10/00	20,6
804554	Toyota	Avensis	9/97-10/00	20,6
804555	Toyota	Yaris	4/99-	17,46
804556	Toyota	Yaris	4/99-	17,46
804557	Toyota	Rav4 I	6/94-6/00	17,46
804701	Audi	50/80/Coupe	8/74-8/86	14,3
	Volkswagen	Derby/Golf I&II/Jetta I&II/Passat (32)/Passat Variant (33)/Polo (86)/ Polo (86C,80)/Polo Classic(86C,80)/Polo Coupe (86C,80)/ Santana (32B)/Scirocco	5/73-	14,3
804706	Audi	50/80/90/100/Coupe	8/74-	17,4
	Seat	Cordoba (6K1/C2)/Ibiza II/Ibiza III (6K1)/Toledo I	5/91-	17,4
	Volkswagen	Caddy I/Derby/Golf I&II&III/Golf III Cabrio/Golf III Variant/Golf IV Cabriolet/ Jetta I&II/Lupo (6X1,6E1)/Passat (32)&(32B)/Passat (3A2,35I)/ Passat Variant (33)/Polo/Polo Classic/Santana/Scirocco/Vento	5/73-	17,4
804707	Audi	80	72-	15,8
804709	Audi	80/100/Coupe	8/76-7/91	15,8
	Seat	Arosa	5/97-	15,8
	Volkswagen	Derby/Golf III/Passat (32B)/Polo (86C,80)/Polo (86CF)/ Polo Classic(86C,80)/Santana (32B)	10/81-	15,8
804714	Volkswagen	1200 Type I/Kaefer	1/57-7/65	22,2
804715	Volkswagen	1200 Type I/Kaefer	1/57-7/65	19,0
804716	Volkswagen	1200 Type I/1300 Type I/181/Kaefer	8/64-	22,2
804717	Volkswagen	1200 Type I/1300 Type I/1500 Type I/Kaefer	1/60-11/73	19,0
804718	Volkswagen	1200 Type I/1300 Type I/1302 Type I/1303 Type I/1500 Type I/181/Kaefer	1/60-	17,4
804719	Volkswagen	1302 Type I/1303 Type I/1500 Type 3 Kombi/Kaefer	8/64-2/76	23,8
804720	Volkswagen	1500 Type 3 Kombi/1500 Type 3 Lim./1600 Type 3	63-73	22,2
804726	Volkswagen	Transporter T1	8/63-8/70	25,0
804728	Volkswagen	Transporter T2/Transporter T3	8/68-7/92	23,8
804729	Volkswagen	LT 28 I Bus/LT 28-35 I	4/75-6/96	25,4
804731	Volkswagen	LT 28-35 I/LT 40-55 I	4/75-96	25,4
804735	Audi	80/90	9/86-7/92	19,0
	Seat	Cordoba (6K1/C2)/Ibiza III (6K1)/Ibiza IV (6L1)	6/99-	19,0
	Skoda	Octavia	9/96-	19,0

**Anvendelsesliste
Buyer's guide
Numerische Liste**



804735	Volkswagen	Derby/Golf II Syncro/Golf III/Golf III Cabrio/Golf III Variant/ Golf IV Cabriolet/Jetta II Syncro/Polo/Polo Classic (6KV2)/ Polo Variant (6KV5)/Vento	10/81-	19,0
804736	Audi	80/100	4/88-	20,6
	Skoda	Octavia	9/96-	20,6
	Volkswagen	Golf III Syncro/Passat (3A2, 35I)	2/88-4/99	20,6
804737	Volkswagen	Transporter T4	7/90-	20,6
804738	Audi	80/100	12/90-1/96	20,6
	Seat	Inca	11/95-	20,6
	Skoda	Octavia	9/96-	20,6
	Volkswagen	Caddy II (Van)/Golf III Syncro/Passat (3A2, 35I)	2/88-	20,6
804739	Audi	A2 (8Z0)	2/00-	17,4
	Seat	Arosa/Cordoba/Ibiza III (6K1)	11/93-	17,4
	Volkswagen	Golf I (Cabriolet)/Golf II/Golf III Cabrio/Golf IV Cabriolet/Lupo (6X1, 6E1)/ Passat (32)&(32B)/Polo/Polo Classic (6KV2)/Santana (32B)/Vento	5/73-	17,4
804804	Volvo	Amazon 122S, B18/Amazon Estate B18/P 121	5/59-5/71	25,4
804805	Volvo	Amazon B18/P 121	5/59-5/71	22,0
804806	Volvo	Amazon B20	9/68-70	22,2
804808	Volvo	340-360	8/75-7/91	20,6
804811	Volvo	440/460	8/88-12/96	20,6
804812	Volvo	440/460	8/88-12/96	20,6
804901	Wartburg	353	6/66-2/75	25,4
804902	Wartburg	353	6/66-2/75	25,4
804903	Wartburg	353	6/66-2/75	25,4
804904	Wartburg	353	2/75-5/91	19,05
805001	Daewoo	Matiz	9/98-	17,46
805101	Daihatsu	Charade (G10)	78-4/83	15,8
805102	Daihatsu	Charade (G10)	78-4/83	15,8
805103	Daihatsu	Charade (G 11)/Charade (G 30)	10/82-	15,8
805105	Daihatsu	Charade (G 100)&(G 101)&(G 102)&(G 200)&(G 202)&(G 203)	2/87-	17,4
805106	Daihatsu	Charade (G 100)&(G 101)&(G 102)&(G 200)&(G 202)&(G 203)	2/87-	17,4
805107	Daihatsu	Rocky	9/89-	25,4
805108	Daihatsu	Gran Move	10/96-	17,46
805109	Daihatsu	Gran Move	10/96-	17,46
805110	Daihatsu	Hijet	1/96-	17,46
805111	Daihatsu	Terios (J1)	10/97-	20,64
805112	Daihatsu	Terios (J1)	10/97-	20,64
805201	Suzuki	Swift I&II	10/83-	17,46
805202	Suzuki	Swift II	3/89-	15,87
805203	Subaru	Justy II	10/95-	17,46
805203	Suzuki	Baleno/Swift II	3/89-	17,46
805204	Subaru	Justy II	10/95-	17,46
805204	Suzuki	Baleno/Swift II	3/89-	17,46
805205	Suzuki	Alto III	9/94-6/02	17,46
805206	Suzuki	Wagon R+	2/98-5/00	15,8
805601	Porsche	924	8/75-8/85	19,0
805801	Trabant	P 601	1/66-4/90	22,2
805802	Trabant	P 601	1/66-4/90	22,2
805803	Trabant	P 601	1/66-4/90	15,87
805804	Trabant	1.1	5/90-12/91	19,05
805901	Barkas	B 1000	4/67-12/91	31,8
805902	Barkas	B 1000	4/67-12/91	31,8
805903	Barkas	B 1000	4/67-12/91	25,4
809301	Chrysler	Voyager II	1/95-3/01	17,5

**Anvendelsesliste
Buyer's guide
Numerische Liste**



				Ø
809302	Chrysler	Voyager I	8/84-1/95	19,0
809906	Hanomag	Hanomag	-74	22,0
	MB	BM 605/606/BM 607/608		22,0
809907	Hanomag	Hanomag	73-74	22,0
	MB	BM 605/606/BM 611		22,0
809910	Citroen	LNA/Visa	11/78-	20,6
	Peugeot	104		20,6
809911	Citroen	LN/LNA/Visa	9/77-	22,0
	Peugeot	104	9/76-	22,0
	Talbot	Samba	1/81-10/86	22,0
809914	BMW	3 Series (E21)&(E30)/5 Series (E28)	6/75-12/87	19,0
	Ford	Taurus	62-64	19,0
809915	Ford	Escort I	1/68-2/76	19,0
	Rover Group	Morris Marina/Triumph Herald/Triumph Spitfire	61-80	19,0
	Triumph	Herald/Spitfire II & III	1/61-12/71	19,0
809916	Rover Group	Austin Mini MK I/Austin MK I/Rover Mini MK I	59-	19,0
	Saab	95/96	62-80	19,0
809917	Rover Group	Austin Mini MK I/Mini Cooper (MK III) (24)	64-74	16,0
	Saab	95/96	62-80	16,0
809919	Rover Group	Austin Maxi/Morris Marina	69-8/82	17,4
	Vauxhall	Firenza/Viva	70/78	17,4
809920	Ford	Capri/Escort II	12/75-86	19,0
	Volvo	340-360	8/75-7/91	19,0
809922	Ford	Escort I	1/68-2/76	19,0
	Rover Group	Morris Marina	4/71-72	19,0
809923	Ford	Escort I	1/68-2/76	19,0
	Rover Group	Morris Marina/Triumph Herald	61-72	19,0
	Triumph	Herald	1/61-12/71	19,0
809925	Bedford	CF Van	69-	22,0
	Ford	Transit	65-9/68	22,0
809926	Ford	Transit	70-86	22,2
	Rover Group	Sherpa	74-	22,2
809927	Ford Transit	70-86	22,2	
	Rover Group	Sherpa	74-	22,2
809928	Bedford	CF Van	69-	15,7
809929	Peugeot	505	8/79-12/93	20,6
	Talbot	Tagora	6/80-12/87	20,6
809930	Opel	Ascona B/Kadett C/Manta A&B	-86	19,0
	Vauxhall	Chevette	3/75-12/85	19,0
809931	Peugeot	305 II	10/82-7/90	20,6
	Talbot	1307-1510/Horizon	7/75-6/86	20,6
809932	Citroen	LN	7/76-8/77	22,2
	Peugeot	104/309 I/504/505	7/68-12/93	22,2
	Renault	11/14/5 Super/9/Express (Rapid)/18 Berline	5/76-	22,2
809933	Citroen	LN	7/76-8/77	22,2
	Peugeot	104/309 I/504/505	7/68-12/93	22,2
	Renault	11/14/5 Super/9/Express (Rapid)/18 Berline	5/76-	22,2
809934	Peugeot	306/309 II/505	8/79-7/95	20,6
	Talbot	Tagora	10/80-7/83	20,6
809935	Citroen	LN/LNA/Visa	9/77-	22,2
	Peugeot	104	9/76-	22,2
	Talbot	Samba	1/81-10/86	22,2
809936	Alfa Romeo	AR 6	9/86-12/89	25,4
	Citroen	C 25	1/83-	25,4

**Anvendelsesliste
Buyer's guide
Numerische Liste**



















				Ø
809936	Fiat	Ducato	11/82-94	25,4
	Peugeot	J 5	11/82-	25,4
	Renault	Master I	8/80-7/98	25,4
809938	Daihatsu	Charmant	11/76-7/87	19,0
	Toyota	Carina/Celica/Corolla/Corolla (KE)&(_E7_)	5/73-5/88	19,0
809939	Daihatsu	Charmant	11/81-7/87	20,6
	Toyota	Corolla KE70 Van&KE76	2/80-	20,6
809940	Peugeot	305 II/405 I & II/405 I Break/405 II Break	10/82-10/96	20,6
	Talbot	1307-1510/Horizon/Rancho	7/75-6/86	20,6
809941	Peugeot	309 I	9/85-6/89	22,2
	Renault	5 Super/9/11/14/18 Berline/21/Express (Rapid)/Fuego	5/76-	22,2
809942	Peugeot	309 I	9/85-6/89	22,2
	Renault	5 Super/9/11/14/18 Berline/21/Express (Rapid)/Fuego	5/76-	22,2
809943	Citroen	C 15	10/84-12/97	22,0
	Renault	18 Berline/18 Break/Espace I&II/Fuego	2/79-	22,0
	Talbot	1307-1510/Solara	7/75-4/84	22,0
809944	Citroen	C 25	10/81-12/82	22,2
	Fiat	Ducato	11/81-10/82	22,2
	Peugeot	J 5	9/81-10/82	22,2
809945	Peugeot	309 I	10/85-7/89	17,4
	Renault	9/11	9/81-12/88	17,4
809946	Peugeot	309 I	10/85-7/89	17,4
	Renault	9/11	9/81-12/88	17,4
809947	Citroen	ZX	3/91-8/92	20,6
	Peugeot	309 II	7/89-12/93	20,6
809948	Citroen	ZX	3/91-8/92	20,6
	Peugeot	309 II	7/89-12/93	20,6
809949	Citroen	ZX/Xsara	9/92-	20,6
	Peugeot	306	5/93-	20,6
809950	Citroen	ZX/Xsara	9/92-	20,6
	Peugeot	306	5/93-	20,6
809951	Honda	Civic/Prelude I/Quintet	11/78-	17,4
	Rover Group	Rover 200/Triumph Acclaim	81-	17,4
809953	Honda	Civic/Concerto	8/89-12/95	19,0
	Rover Group	Rover 200/Rover 400 (XW)	10/89-10/95	19,0
809954	Honda	Civic/Concerto	8/89-12/95	19,0
	Rover Group	Rover 200/Rover 400 (XW)	10/89-10/95	19,0
809955	Citroen	C 25	87-	27,4
	Fiat	Ducato	9/86-94	27,4
	Peugeot	J 5	9/87-	27,4
809957	Citroen	AX/Saxo	5/91-	19,0
	Peugeot	106 I&II	9/91-	19,0
809958	Citroen	AX/Saxo	5/91-	19,0
	Peugeot	106 I&II	9/91-	19,0

ILLUSTRATIONER UDLUFTNINGSSKRUER
 ILLUSTRATIONS BLEEDER SCREWS
 ABBILDUNGEN ENTLÜFTUNGSSCHRAUBEN



















SKALA/SCALE/MÅSTAB 1:1

<p>89010</p> 	<p>M8 x 1,25 9 x 41,5</p> <p>Mercedes, Opel Vauxhall</p>	<p>89039</p> 	<p>M10 x 1 11 x 30,0</p> <p>Alfa Romeo, Citroën, Fiat, Ford, Hyundai, Mercedes, OM, Peugeot, Princess, Rover, Saab, Volvo, VW</p>
<p>89011</p> 	<p>M8 x 1,25 9 x 35,5</p> <p>Mercedes, Opel, Saab, Skoda, Vauxhall, Volvo</p>	<p>89040</p> 	<p>M12 x 1 13 x 31,4</p> <p>Ford</p>
<p>89013</p> 	<p>M6 x 1 7 x 38,0</p> <p>Audi, Subaru, VW</p>	<p>89049</p> 	<p>3/8 x 24UNF 10 x 34,0</p> <p>Ford, Hillmann, Humber, Rover, Singer, Sunbeam, Talbot (Simca), Vauxhall, Volvo</p>
<p>89015</p> 	<p>M8 x 1,25 9 x 32,4</p> <p>Citroën, Honda, Mercedes, Opel, Skoda, Vauxhall</p>	<p>89053</p> 	<p>M7 x 1 7 x 21,7</p> <p>Alfa Romeo, BMW, Citroën, Daica, Daihatsu, Ford, Isuzu, Mazda, Nissan, Peugeot, Rover, Renault, Saet, Tablot, Volvo, VW</p>
<p>89017</p> 	<p>M10 x 1 10 x 34,0</p> <p>Daihatsu, Honda, Mitsubishi, Nissan (Datsun), Rover, Subaru, Suzuki, Toyota, VW</p>	<p>89053X</p> 	<p>M7 x 1 7 x 26,2</p> <p>Alfa Romeo, BMW, Citroën, Daica, Daihatsu, Ford, Isuzu, Mazda, Nissan, Peugeot, Rover, Renault, Saet, Tablot, Volvo, VW</p>
<p>89018</p> 	<p>M10 x 1 10 x 36,5</p> <p>Fiat, Ford, OM, Rover, Talbot (Simca), Triumph, Volvo</p>	<p>89069</p> 	<p>M7 x 1 7 x 28,7</p> <p>Alfa Romeo, Ford, Mazda, Peugeot, Renault, Rover, Talbot</p>
<p>89019</p> 	<p>M10 x 1 11 x 36,0</p> <p>Ford, Toyota, VW</p>	<p>89085</p> 	<p>M8 x 1,25 9 x 49,0</p> <p>Ford, Mercedes</p>
<p>89033</p> 	<p>M6 x 1 7 x 29,0</p> <p>Audi, BMW, Saab, VW</p>	<p>89086</p> 	<p>M7 x 1 7 x 30,5</p> <p>Alfa Romeo, Audi, BMW, Citroën, DAF, Daihatsu, Fiat, Ford, Mazda, Mitsubishi, Peugeot, Renault, Saab, Subaru, Talbot, Toyota, Volvo, VW</p>

ILLUSTRATIONER UDLUFTNINGSSKRUER
 ILLUSTRATIONS BLEEDER SCREWS
 ABBILDUNGEN ENTLÜFTUNGSSCHRAUBEN



SKALA/SCALE/MÅSTAB 1:1

89087	M7 x 1	7 x 38,3		Alfa Romeo, Audi, BMW, Citroën, Daihatsu, Opel, Peugeot, Subaru, Talbot, Vauxhall, Volvo, VW	890101	M10 x 1,25	10 x 28,0		Honda
89088	M7 x 1	9 x 33,0		Mercedes, Mitsubishi, Opel, Saab, Talbot, Toyota, Vauxhall	890105	1/4" x 28UNF	7 X 28,0		Rover, Vauxhall
89089	M8 x 1	9 x 32,0		Ford, Mazda	890107	3/8 x 24UNF	10 x 31,0		Ford, MG, Riley, Rover, Vanden Plas, Wolseley
89090	M8 x 1	9 x 33,5		Mazda, Opel, Vauxhall	890108	3/8" x 24UNF	10 x 36,6		Ford, Hillmann, Jaguar, Lotus, Morgan, Rover, Saab, Sunbeam, Talbot, Triumph, Vauxhall
89091	M8 x 1	8 x 37,9		Mazda	890120	1/4" x 28UNF	8 x 28,0		Iveco, Volvo
89092	M8 x 1,25	8 x 34,8		Citroën	890120X	1/4" x 28UNF	8 x 28,0		Special for rebuilding Volvo
89094	M7 x 1	8 x 55,5		Ford	890125				Dust Cap All Bleeder Screws
890100	M8 x 1,25	8 x 24,5		Alfa Romeo, Autobianchi, Citroën, Fiat, Honda, Lada, Lancia, Peugeot, Polmo, Rover, seat, Talbot, Zastava	890126				Dust Cap Special



Autoteile Deutschland GmbH

NK Autoteile Deutschland GmbH
Auestrasse 10 D-99817 Eisenach

Tel.: 03691 - 257100
Fax: 03691 - 257110

e-mail: verkauf@nk-autoteile.de
www.nk-autoteile.de/www.nk-shop.de